

A DUAL PURPOSE CONVERTER UNIT

# Practical Television '66

AUGUST  
1960

AND TELEVISION TIMES



## CONTENTS

FRAME TROUBLES EXPLAINED

CHANGING C.R. TUBES

SERVICING TV RECEIVERS

IS IT THE TUBE?

COMMON TV FAULTS

ETC. ETC. ETC.

# TELEVISION SPARES

**All Makes      All Models      By return of post**

**LINE OUTPUT TRANSFORMERS      FRAME OUTPUT TRANSFORMERS  
DEFLECTOR COILS**

**LINE AND FRAME BLOCKING OSCILLATOR TRANSFORMERS**

**ALL POTENTIOMETER AND SLIDER CONTROLS**

**MAINS DROPPERS**

**METAL RECTIFIERS**

**GERMANIUM DIODES**

**FOCUS MAGNETS**

**ION TRAPS**

**E.H.T. CONDENSERS**

Our Range of Spares is probably the most extensive in the country and includes all Spares for Tape Recorders, Radio and Record Player Units.

Technical Advice Free. Service Manuals supplied on loan.

Terms: C.W.O. or C.O.D. All Components are supplied at list prices, plus 2/6 p.p.

*Please enclose S.A.E. with all enquiries.*

## NEWBURY RADIO

272, ROMFORD ROAD, FOREST GATE, LONDON, E.7.

MARyland 3100

### SPECIAL FOR THE "HAMS" RADIO STATION

*Illustrated*

$\frac{1}{8}$  inch detachable bit  
soldering instrument  
List No. 70

Combined Protective Unit  
with Wiper/Abrasion Pad  
and Solder Reel  
List No. 700

Apply **SALES & SERVICE**

**ADCOLA**

(Regd. Trade Mark)

**GAUDEN ROAD  
CLAPHAM HIGH ST.  
LONDON, S.W.4**

Telephones:  
MACaulay 4272 - 3101

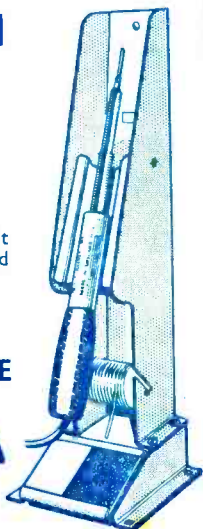

British & Foreign  
Patents, Registered  
Designs, etc.

Telegrams:  
"SOLJOINT, LONDON"

### TELEVISION TUBES REBUILT

- ★ A NEW GUN IN EVERY TUBE
- ★ BUY DIRECT FROM THE FACTORY
- ★ 12 MONTHS' GUARANTEE

12 inch £5.0.0

14 inch £5.10.0

17 inch £6.10.0

*Immediate dispatch on receipt of Remittance*  
Carriage and insurance 12/6 extra  
**£1 Refunded on receipt of your  
old Tube**

SPECIAL TERMS TO THE TRADE

**MARSHALLS for TELEVISION LTD.**  
131 St. Ann's Road, Tottenham, London, N.15  
STAMFORD HILL 3267

## BRAND NEW AM/FM (V.H.F.) CHASSIS AT £13.6.8. (P. & P. 10/-)

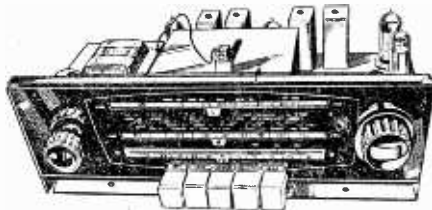

Why buy a F.M. Tuner at the same price? Tapped input 220-225 v. and 226-250 v. A.C. ONLY. Chassis size 15 x 6 1/2 x 5 1/2 in. high. New manufacture. Dial 1 1/2 x 4 in. in gold and black. Pick-up. Extension Speaker, Ae., E., and Dipole sockets. Five "piano" push buttons—OFF, L.W., M.W., F.M. and Gram. Aligned and tested. With all valves & O.P. Transformer. Tone-control fitted. Covers 1,000-1,900 M.; 200-500 M.; 88-99 Mc's. Valves E2B0 rect., ECH81, EF89, EABC90, EL84, ECC85. Speaker & Cabinet to fit chassis. 47/6. 10 x 6 in. ELLIPTICAL SPEAKER, 20/-.

TERMS:—(Chassis) £4.16.8 down—10/- carr.—and 6 Monthly Payments of 30/-, or with Cabinet & Speaker £5.9.2 down and 7 Monthly Payments of 32/-.

We are specialists in ITA Converter. Our converters give direct switching ITA to BBC, metal rectifier, co-axial plus. Can be fitted in 5-10 mins., and need no alteration to your set. ALL AREAS. ALL SETS. ALL CHANNELS. 12 months' guarantee (3 months on valves).

### "READY TO USE" ITA CONVERTER

Separate gain controls. Valves PCF80 and PCC84. Switch positions ITA (1)—ITA (2)—BBC. Bakelite moulded cabinet 8 1/2 x 4 x 6 in. £5.5.0. P. & P. 3/-.

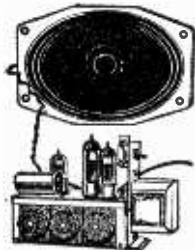

**3-VALVE AMPLIFIER (INCL. RECT.)** Capable of giving 6 watts. Mains and output transformers. Valves ECC81, EL84 and Rect. 3 Controls, volume, bass and treble. On/Off switch. Fully guaranteed. Chassis size 6 1/2 x 3 x 2 1/2 in., with 7 x 4 in. elliptical speaker or 6 in. round (Goodmans); state which

Only 67/- (P. & P. 3/-)

### (STUPENDOUS OFFER!) 13-CHANNEL INCREMENTAL TUNER



I.F. 34-38 Mc/s complete with valves PCF80 and PCC84. Removed from chassis but in working order.

15/- (2/6 P. & P.) Knobs 2/6 extra. Some tuners less valves 7/6.

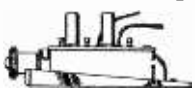

**NEW ITA AND BBC TUNER.** By well-known manufacturer for superhet TVs with 35-38 Mc/s I.F. For all areas; covers all 13 channels. Switch gives BBC and two ITA selections. Suits G.E.C. sets BT4543, 4544, 5146, 5147, 5543, 5642 and 6641

without alteration. Easily adapted as aerial converter, and instructions can be provided free. Has ITA and BBC co-axial sockets and separate gain controls. WITH VALVES PCF80 and PCC84, 22/6 (P. & P. 3/-). Some without valves at only 12/6 (P. & P. 3/-).

**PERSPEX UNSCRATCHED.** (Post 2/- each or 6 post free.) 12 1/2 x 9 1/2 x 4 in. clear, 4/6; 14 1/2 x 11 x 4 in. clear, 5/-; 15 x 12 x 4 in. tinted, 6/-; (Also 15 x 12 in. slightly scratched at 3/-).

**AUTOMATIC RECORD CHANGERS. COLLAR CONQUEST** with manual play also. Turnover crystal pick-up, 4-speed, A.C. mains 200-250 v., see illus.

£7.10.0 (5/- P. & P.)



B.S.R. 4-speed U.A.8, auto-changer £6.15.0 (5/- carriage).

**GLADSTONE RADIO**  
3 CHURCH ROAD, BRISTOL 5  
and 247 NEW ROAD, PORTSMOUTH

### THE "CARY" TEST METERS

In moulded case. Prices include Test Prods., Batteries, Instruction Book. FULLY GUARANTEED. Also measure db. Accuracy: A.C., 3 per cent, D.C., 2 per cent.



A-10 £4.17.6

B-20 £6.10.0

A-10—2K ohms/v. on A.C. and D.C. volts (10, 50, 250, 500 and 1000 v.); 10K and 1M ohms; 1 mA, 25 mA and 250 mA, D.C. Size: 5 1/2 x 3 1/2 x 1 1/2 in. Weight 17 ozs. B-20—10K ohms/v. on 0.5 v. and 2.5 v.; 4K ohms/v. on 10, 50, 250, 500 and 1000 v., A.C. and D.C. Resistance, 2K, 200K, 2M and 20M ohms; D.C. current, 100 microA, 2.5 mA, 25 mA, 250 mA. Size: 5 1/2 x 3 1/2 x 2 1/2 in. Weight, 24 ozs.

### THE BRAYHEAD TURRET TUNER.

£7.0 post free. Complete with booklet and fitting instructions. State set and model No. when ordering. Converts your 5-channel BBC only set to receive ITA as well.

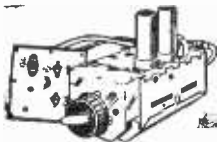

**ITA AERIALS** clipping to existing mast 1-2 in. dia. 3-element. 22/-; 5-el., 30/-; 9-el., 50/-; Loft mounting, 3-el., 20/-; 5-el., 26/-; Combined single BBC and 5-el. ITA, 75/- with chimney-lashings; Co-axial cable semi-air-spaced, 7d. yd or 20 yds., 11/-; Aerial prices carr. paid. Postage on cable 1/-.

**50 SILVERED MICA AND CERAMIC CONDENSERS, 10/-; 50 RESISTORS, 5/- ALL NEW.**

**NEW WAXED TUBULARS,** 350 v. or above, 3 of each, 0.001, 0.002, 0.005, 0.01, 0.02, 0.05, 0.1 mF. Total 21 for 4/6, post paid.



**GRAMOPHONE AMPLIFIER** with 5 in. SPEAKER. On Fabric-covered Baffle 12 1/2 x 5 in. Mains and Output Transformers. Metal Rectifier, ECL82 Valve. Tone and

Volume Controls. On/Off switch. plenty of Volume. Fully Guaranteed. Two Knobs supplied. Ready to play. Useful for Stereo.

ONLY 57/-, post 3/-



### LISTEN WITHOUT INTERFERENCE

Fully built V.H.F./F.M. set. Wired, aligned and tested. 6 Mullard valves, with mains transformer, 36-95 Mc/s. ONLY £8.8.0 (4/- carr.). Cheap room-dipole 10/-, 300 ohm twin feeder, 6d. yd. All with 12 months' guarantee.

Delivery by return. C.O.D. 2/- extra. Terms: Cash with order or one-third down and balance plus 7/6 (up to £7.10.0) in four equal monthly payments. Balance over £7.10.0 add 1/- in £1 and pay in not more than 6 monthly payments. See special terms for A.M.-F.M. chassis. All new goods unless stated. Send 6d. for 16-page catalogue.

### POSTED ORDERS TO CAMBERLEY PLEASE

58A HIGH STREET, CAMBERLEY, SURREY. Tel. 22791  
(Camberley closed Sats; Bristol and Portsmouth closed Weds.)



# DOUBLE BEAM "SCOPE"

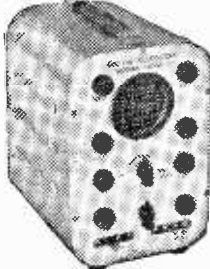

for D.C. & A.C. APPLICATIONS

Engineered to precision standards, this high-grade instrument is made available at the lowest possible price, incorporating the essential features usually associated with luxury instruments.

This "SCOPE" will appear particularly to Service engineers and Amateurs. A high gain, extremely stable differential Y-amplifier (30 mV/C.M.). Provides ample sensitivity with A.C. of D.C. inputs. Especially suitable for measurement of transistor operating conditions where maintenance of D.C. levels is of paramount importance. Push-pull X amplifier; Fly-back suppression; Internal Time-base Scan Waveform available for external use; pulse output available for checking TV Line O/P Transformers, etc.; Provision for external - I/P and CRT Brightness Modulation. A.C. mains 200/250 v. £19.19.0, plus P. & P. 7/6, or 50/- deposit, plus P. & P. 7/6 and 12 monthly payments of 33/4.

FULL 12 MONTHS' GUARANTEE INCLUDING VALVES AND TUBE.

## ALIGNMENT ANALYSER TYPE MC12

A.C. mains 200/250 v. Provides: "Wobulator" (Swept Frequency) operation, for FM/TV alignment linear frequency sweep up to 12 Mc/s. From 400 kc/s-80 Mc/s. Capacitance Measurement. Two ranges provided 0-60pF and 0-120pF. Special Facility enables true resonant frequency of any tuned cct. I.F. transformer, etc., to be rapidly determined. Cash price £6.19.6, plus 5/- P. & P. H.P. terms 25/- deposit plus 5/- P. & P. and six monthly payments of 21/6.



## LINE E.H.T. TRANSFORMER



With built-in line and width control, 14 KV. Scan coil, 90lin. deflection, on ferrite yokes. Frames O.P. transformer pl. 18 KV. smoothing condenser. Can be used for 14in., 17in. or 21in. tubes. Complete with circuit diagram.

29/6 Plus 4/- P. & P.

As above, but for 625 lines, £2.10.0, plus 4/- P. & P.

Focus Magnet suitable for the above (state tube). 10/-, plus 2/6 P. & P.

## F.M. TUNER UNIT

by famous German manufacturer. Coverage 88-100 Mc/s. Complete with EC085, size 4in. x 2in. x 2in.

25/- P. & P. Circuit Diagram 1/-.

10.7 Mc/s. I.F. and Discriminator Coil, 4/- pair.

## MAINS TRANSFORMERS

All with tapped primaries. 200-250 volts, 0-160, 180, 200 v., 60 ma., 6.3 v. 2 amps., 10/6, 280-0-280 80 ma., 6.3 v. 2 amp., 6.3 v. 1 amp., 10/6, 350-0-350 v., 70 ma., 6.3 v. 1 amp., 6.3 v. 2 amp., 10/6, 250-250 v. 70 ma., 6.3 v. 2 amp., 10/6. Postage and packing on the above, 3/-.

## SURFACE BARRIER TRANSISTORS

Type SB905, 15 Mc/s, 7/6 each. 100% AUDIO TRANSISTORS, 5/- each.

## TRANSISTOR TESTER

For both P.N.P. and N.P.N. transistors incorporating moving coil meter. In metal case, size 4 1/2 x 3 1/2 x 1 1/2 in. Scale marked in gain and leakage. Complete and ready for use. 19/6 Plus 2/6 P. & P.

## BUILT POWER SUPPLY UNIT

A.C. Mains 200-250 v. D.C. Output 250 v. at 75 ma., also 6.3 v. 2 amp. heater winding. 21/- Plus 3/6 P. & P.

## SIGNAL GENERATORS

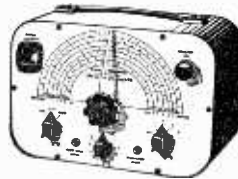

£6.19.6 or 25/- deposit and 6 monthly payments of 21/6. P. & P. 5/- extra. Coverage 100 Kc/s-100 Mc/s on fundamentals and 100 Mc/s to 200 Mc/s on harmonics. Metal case 10in. x 6 1/2in. x 5 1/2in. grey hammer finish. Incorporating three miniature valves and Metal Rectifier. A.C. Mains 200/250. Internal Modulation of 400 c.p.s. to a depth of 30%; modulated or unmodulated R.F. output continuously variable. 100 milli-volts, C.W. and mod. switch, variable magic-eye as output indicator. Accuracy plus or minus 2%.

Cash £4.19.6 or 25/- deposit and 4 monthly payments of 21/6. Plus Postage and Packing 5/-.

Coverage 120 Kc/s-84 Mc/s. Metal case 10in. x 6 1/2in. x 4 1/2in. Size of scale 6in. x 3 1/2in. 2 valves and rectifier. A.C. mains 230-250 v. Internal modulation of 400 c.p.s. to a depth of 30% modulated or unmodulated R.F. output continuously variable. 100 milli-volts. C.W. and mod. switch variable A.F. output and moving coil output meter. Grey hammer finished case and white panel. Accuracy plus or minus 2%.

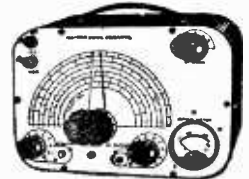

## SIGNAL & PATTERN GENERATOR

£6.19.6 P. & P. 5/-.

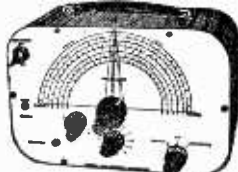

Or 25/- deposit. P. & P. 5/- and 6 monthly payments of 21/6. Coverage 7.8 Mc/s-210 Mc/s. in five bands, all on fundamentals. slow motion tuning audio output. 8 vertical and horizontal bars, logging scale. In grey hammer finished case with carrying handle. Accuracy ± 1% A.C. mains 200-250 v.

## CHANNEL TUNER

Will tune to all Band I and Band III stations. BRAND NEW by famous manufacturer. Complete with P.C.C. 84 and P.C.F. 80 valves (in series). I.F. 16-19 or 33-38. Also can be modified as an aerial converter. (Instructions supplied). Complete with knobs. 22/6 Plus 3/6 P. & P.

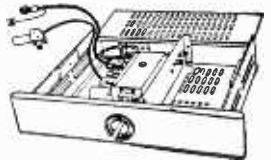

## HEATER TRANSFORMER

To suit the above, 200-250 v., 6/-, Plus 1/6 P. & P.

## 8-WATT PUSH-PULL AMPLIFIER

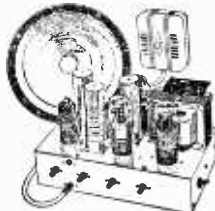

COMPLETE WITH CRYSTAL MIKE AND 8in. LOUSPEAKER

A.C. mains 200-250 v. Size 10in. x 6in. x 2in. Incorporating 6 valves. H.F. pen., 2 triodes, 2 output pens and rectifier. For use with all makes and type of pick-up and mike. Negative feed back. Two inputs, mike and gram., and controls for same. Separate controls for Bass and Treble lit. Response flat from 40 cycles to 15 Kcs. ± 2 db; 4 db down to 20 Kcs. Output 8 watts at 5% total distortion. Noise level 40 db down all hum. Output transformer tapped for 3 and 15 ohm speech coils. For use with Std. or L.P. records, musical instruments such as Guitars, etc. £4.19.6 P. & P. 7/6.

Or 20/- deposit Plus P. & P. 7/6, and 4 monthly payments of 23/-.

## RADIO & T.V. COMPONENTS (Acton) LTD.

23 HIGH STREET, ACTON, LONDON, W.3.

All enquiries S.A.E. GOODS NOT DESPATCHED OUTSIDE U.K.

## 7-VALVE AM/FM RADIOGRAM CHASSIS



Valve Line up:  
ECC85, ECH81,  
EF89, EABC80,  
EL84, EMB1, EZ80.



3 waveband and switched gram positions. Med. 200 m.-500 m Long 1,000 m.-2,000 m. VHF/FM 88-95 Mc/s.

4 Controls. Vol., On-off, Tone, Tuning, Wavechange. P.U., Ae. and E., and speaker sockets. Magic eye tuning. Philips continental tuning insert with permeability tuning on FM, and combined AM/FM IF transformers, 460 Kc/s and 10.7 Mc/s. Dust core tuning all coils. Latest circuitry, including AVC and Neg. Feedback. 3 watt output. Sensitivity and reproduction of a very high standard. Chassis size 1 3/4" x 6 1/2". Height 7 1/2". Edge illuminated glass dial 1 1/4" x 3 1/4". Vertical pointer, Horizontal station names, gold on brown background. A.C. 200/250 v. operation.

Aligned and tested ready for use **£13.10** Carr. & Ins. 5/-.

Complete with 4 Knobs—walnut or ivory to choice.

Three ohm P.M. speaker only required. Recommended quality speakers.

8in. Goodmans special cone. .... 21/6

10in. Roia (Heavy Duty)..... 30/- Post & Pkg. 1/6

## NEW VALVES

All Guaranteed

### NEW REDUCED PRICES

1T4	9/-	6BH42	10/6	EZ80	7/6
1R5, 1B5	7/6	ECC80	10/6	EZ81	7/6
35Z, 3V4	7/6	ECL82	10/6	MU14	9/6
6Z4	9/6	EF80	8/-	PCC84	9/6
DAF98	9/-	EF86	12/6	PCF80	9/6
EP98	9/-	EF91	7/6	PLC83	12/6
DI98	9/-	EL41	9/6	PL81	12/6
DL96	9/-	EL84	9/6	PL82	9/6
EABC80	8/6	EY51	9/6	PL83	10/6
ECF80	9/6	EY86	10/-	PL80	7/6

## TRANSISTOR 'ONE-WATT' AMPLIFIER

6 v. Battery operated

Latest Push-Pull, 4 Transistor circuit giving full 1 watt Output into standard 3 ohm speaker. Good sensitivity and improved freq. response. Neg. feedback. Var. Tone and Volume Controls. Chassis Size 8 1/2" x 3 1/4" x 1 1/4". Current consumption 10 mA quiescent—250 mA at 1 watt.  
LATEST REDUCED PRICE by POPULAR DEMAND NOW ONLY 79/6, p. & p. 1/6. Circuit and instructions 1/6 (free with kit).

## THE TOURIST PORTABLE

Still the Most Popular

4 valve. Med. and L.W., lightweight battery Radio. Size only 8 x 3 1/4 x 4in. Weight 3 1/2lb. with battery (B114 7/6 extra) P. & P.  
Complete receiver component kit .. 57/6 1/6  
Set 4 miniature valves (96 series) .. 36/- 9d.  
6in. Speaker and Output Trans. .. 21/- 1/6  
Cabinet, Dial and Knobs, etc. .. 22/6 2/-  
Latest superb circuitry delayed AVC and A.F. Neg. feedback.  
Complete kit—BARGAIN—only £6.10p, post free. Send for Booklet NOW: 1/6 post free.  
This kit is one of our most popular Bargain Buys. Scores of delighted customers. Simple and easy to build. Quality and ease of very high standard. Recently featured in popular radio magazine.

ONLY A FEW ITEMS ARE LISTED FROM OUR COMPREHENSIVE STOCK. WRITE NOW FOR FULL BARGAIN LISTS, 3d.

## JASON FM TUNER UNITS

(87-105 Mc/s)

Designer-approved kits of parts for these quality and highly popular tuners available as follows.

**STANDARD MODEL (FMT1)**—as previously extensively advertised. COMPLETE KIT, 5 gns. Set of 4 spec. valves, 30/-.

**MODEL (FMT2)**—attractively presented shelf mounting unit in enclosed Metal Cabinet with Built-in Power Supply. COMPLETE KIT, 27. Set of 3 spec. valves, 33/6.

**NEW JASON COMPREHENSIVE P.M. HAND-BOOK**, 2/6, post free. ALL UNITS POST FREE. 48 hr. Alignment Service, 7/6, p. & p. 3/6.

**LATEST MODEL JTV2**—Switched Band 1-2-3. AM/FM Unit with AFC. Complete Kit £12.19.6.

## REGUNNED TV TUBES

New Reduced Prices ... and now 12 months' guaranteed! All tubes rebuilt with new heater cathode and gem assembly, reconditioned virtually as new. 12in., 25 14in., £6.10.0 17in., 26, 10/- Part Exchange allowance on old tube. Carr. & Ins. 10/-. Comprehensive stocks. Quick delivery.

## TRANSISTORS SPECIAL OFFER

BVA 1st Grade Types, BRAND NEW.  
Mazda XA102, 18/6; XA101, 14/6; XA104, 10/6;  
O470, 8/6; XB102, 10/-; XA103, 15/-; XA104, 18/-;  
O470, 2/8; GET114, 9/6; GET15, 12/6 (matched prs. 25/-).

## 2-valve R/PLAYER AMPLIFIER Mk.2

Latest developed circuit giving a high fidelity response and greater output (2-3 watts) using twin stereo valve ECL82 and neg. feedback Tone Control. Complete with knobs, etc., wired and tested ready to fit in cabinet below. ONLY £2.17.6, p. & p. 1/-. 6in. speaker and matching transformer, 22/-, p. & p. 1/6.

**CABINET**—Record Player, Contemporary styled fawn and brown, cream interior. 18 1/2 x 13 1/2 x 8 1/2in. Fitted speaker Baffle Board, etc. Bargain, 3 gns. Carr. 3/6.

## BAND 3 TV CONVERTER

All channels 7-13 (180-206 Mc/s).  
Mk.2 Model. Using ECC84 and EF80 valves. 18db gain. 200-250 v. A.C. Size 6 1/2 x 3 x 4in. Simple to fit, ready to use. Only 79/6, p. & p. 2/6.  
B1-B3 changeover Sw. and BBC Aerial Socket fitted and wired, 8/- extra.  
Band 3 Aerials. Single Dipole, 13/9; 3 Element Beam, 25/-, etc.

## CYLDON TURRET TUNERS EX MFRS.

Brand New. IF 34-38 Mc/s complete with valves PCF80 and PCC84. Less Knobs. Bargain Buy—Only 39/6. STATE CHANNELS REQUIRED.

## COAX 80 ohm CABLE

Now only 6d. yard

High grade low loss Cellular Air Spaced Polythene—jin. diam.—Famous Mfr.

### BARGAIN PRICES—SPECIAL LENGTHS

20 yds. .. .. . 9/- P. & P. 1/6  
40 yds. .. .. . 17/6 P. & P. 2/-  
80 yds. .. .. . 29/- P. & P. 3/-  
Coax Plugs, 1/-; Coax Sockets, 1/-; Couplers, 1/8;  
Cable End Sockets, 1/8; Outlet Boxes, 4/6.

## CRT. HTR. ISOLATION TRANSFORMERS

New improved types, low capacity, small size and tag terminated, Prim. A.C. 200/250 v. Secondaries 270, +25%, +50% BOOST for 2 v. 4 v., 6.3 v., 12 v. and 13 v. Tubes. EA Type, 12/6 each, p. & p. 1/6.

## RECORD PLAYER BARGAINS

All brand new latest 4-speed Models—Fully Guaranteed.

**SINGLE PLAYERS—B.S.R. (TU9)** with "FUL-FIT" P.L.U., 60/-.

Collaro Junior, 90/-; Garrard TA Mk.2 with GCS Head, £7.19.6; Garrard 4HF Transcription Unit, £18, carr. 3/6.

**AUTO CHANGERS—B.S.R. (UAS)**, £6.19.6; UAS Stereo, £7.19.6; UA14, £7.19.6; Collaro Conquest, £7.19.6; Garrard RC121 (GCS Xtal) Mk.2, 9 1/2 gns., carr. 4/6.

## SPECIAL—NEW RELEASES

**GARRARD RC210**, 4-speed Autochanger Model with latest features and GCS Plug-in Head only 10 gns., carr. 4/6.

**E.M.I.** 4-speed Single Player with Auto Stop/Start Dual Turnover Cartridge for Stereo and Monaural L.F. and 76—Bargain Buy at £6.19.6, carr. 3/6.

Terms: C.W.O. or C.O.D. Kindly make cheques, P.O.s etc., payable to T.R.S. Post/Packing up to 1lb. 7d., 1lb. 1/1, 3lb. 1/6, 6lb. 2/-, 10lb. 2/9

Hours: 9 a.m.—6 p.m. 1 p.m. Wed. Open all day Saturday.



## RADIO COMPONENT SPECIALISTS (Est 1946)

70 BRIGSTOCK ROAD, THORNTON HEATH, SURREY (THQ 2188)

50 yards Thornton Heath Station.

Buses: 130A, 133, 159, 166 and 190



# Practical Television



## & TELEVISION TIMES

Vol. 10 No. 119

EVERY MONTH

AUGUST, 1960

Editorial and Advertisement Offices:  
**PRACTICAL TELEVISION**

George Newnes, Ltd., Tower House,  
Southampton Street, W.C.2.

© George Newnes Ltd., 1960.

Phone: Temple Bar 4363

Telegrams: Newnes, Rand, London.  
Registered at the G.P.O. for transmission  
by Canadian Magazine Post.

### SUBSCRIPTION RATES

including postage for one year

Inland - - £1.2.0 per annum  
Abroad - - £1.0.6 per annum  
Canada - - 19s. per annum

### CONTENTS

	Page
Editorial .. .. .	553
Telenews .. .. .	554
Servicing TV Receivers ..	556
Add-on Sound Unit ..	558
Frame Troubles Explained	560
Common TV Faults ..	562
Replacing C.R. Tubes ..	564
Is it the Tube? .. ..	569
Dual-purpose Converter Unit .. .. .	572
Stereoscopic Television ..	575
Underneath the Dipole ..	576
Letters to the Editor ..	578
Trade News .. .. .	579
Your Problems Solved ..	583

*The Editor will be pleased to consider articles of a practical nature suitable for publication in "Practical Television." Such articles should be written on one side of the paper only, and should contain the name and address of the sender, whilst the Editor does not hold himself responsible for the manuscripts, every effort will be made to return them if a stamped and addressed envelope is enclosed. All correspondence intended for the Editor should be addressed to: The Editor, "Practical Television," George Newnes, Ltd., Tower House, Southampton Street, London, W.C.2.*

*Owing to the rapid progress in the design of radio and television apparatus and to our efforts to keep our readers in touch with the latest developments, we give no warranty that apparatus described in our columns is, not the subject of letters patent.*

*Copyright in all drawings, photographs and articles published in "Practical Television" is specifically reserved throughout the countries signatory to the Berne Convention and the U.S.A. Reproductions or imitations of any of these are therefore expressly forbidden.*

## T.A.C. Report

THE latest and long awaited report of the Television Advisory Committee was published on 1st June 1960. In March 1956, the then Postmaster General asked the Committee for advice on fundamental technical problems of television development in this country. As most readers will be aware, one of the most important points on which the Committee was asked to report was the question of the technical advantages to be gained from the use of higher line definition standards in Bands I and III and the choice of the standard for Bands IV and V. Many authorities have already proposed that a line definition standard of 625 be adopted in this country but it must be remembered that such a technical change involves also political and economical problems.

In its report, the T.A.C. reaches the conclusion that a change from 405 lines will eventually be desirable. It states that Bands I and III could accommodate a third (405-line) programme of near-national coverage and if TV is to be confined to these bands then a changeover to the higher standards is impracticable. Therefore, if more than three programmes are to be provided, whatever the line standards used, Bands IV and V must be brought into use as indeed they must if a change on merits from 405-line to 625-line standards is desirable even if no additional programme is to be provided.

In our opinion, the definition given by 405 lines is at present adequate but it is doubtful whether any great improvements can be made in the future. With the advent of receivers with large screens, there is a definite case for increasing line definition; even at present, some viewers complain of excessive "lininess" and increasing the number of lines would certainly improve matters. The majority of European countries use the 625-line standard and this is yet another point in favour of its adoption—programme interchanges with the rest of the Continent are becoming more and more important and degradation caused by the standards converters used is a definite disadvantage. However, it is the Committee's opinion that the introduction of the 625-line standard must be accompanied by an 8Mc/s channel if the change is to be worthwhile.

To summarise, it seems that there is an overwhelming case for the eventual adoption of the 625-line standard, beginning with transmissions on Bands IV and V and later on Bands I and III. Naturally, any changeover to new standards would need to be made in accordance with a programme taking into account the interests of the industry, the broadcasting organisations and especially the viewers. In a foreword to the report of the T.A.C., the Postmaster General takes pains to point out that no conclusions have been reached on it by the Government and any changeover would be carefully planned. The 405-line services will be continued for many years. There is no question of 405-line receivers becoming prematurely obsolescent and no one need be deterred from buying a new receiver.

Our next issue, dated September, will be published on August 19th

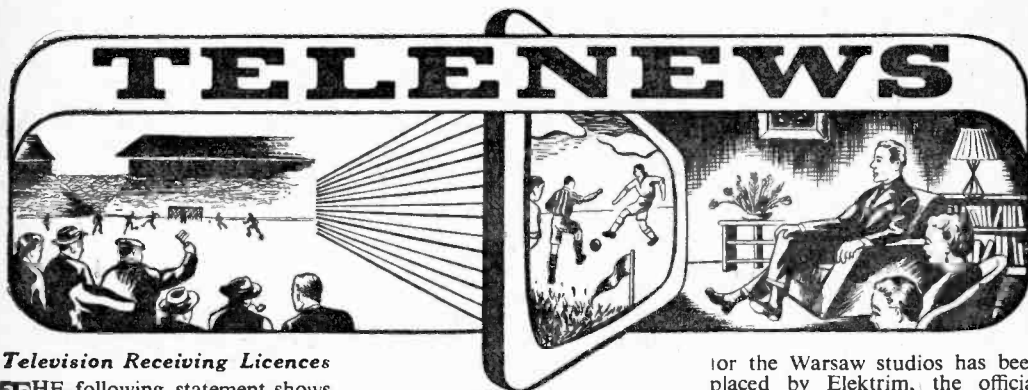

**Television Receiving Licences**

THE following statement shows the approximate number of Television Receiving Licences in force at the end of May, 1960, in respect of television receiving stations situated within the various Postal Regions of England, Wales, Scotland and Northern Ireland.

Region	Total
London Postal	1,836,037
Home Counties	1,442,276
Midland	1,611,587
North Eastern	1,730,327
North Western	1,415,158
South Western	890,574
Wales and Border Counties	640,134
<b>Total England and Wales</b>	<b>9,586,093</b>
Scotland	934,038
Northern Ireland	146,807
<b>Grand Total</b>	<b>10,646,938</b>

**TV in Denmark**

A PLEA for the introduction of commercial television in Denmark has been issued by Peter Hering, chairman of the Danish Advertising Association. Mr. Hering stated that with a registered total of over 300,000 viewers in the country, a minute spot price of 3,000 crowns could be charged to yield an annual revenue on TV advertising of 9,000,000 crowns.

He denied that commercial television was undemocratic in that only big firms could take part in its facilities; medium-sized and smaller firms could make use of TV advertising too. Mr. Hering said that television in the future would be a normal part of daily life and advertising through it was a spur to production and sales.

**15 Camera Channels for ABC**

THE contract for all the television cameras to be used in the new studio being constructed at Teddington, Middlesex, by A.B.C. Television Ltd. has been awarded to E.M.I. Electronic Ltd.

The order for fifteen camera channels is of particular importance in view of the careful assessment which A.B.C. Television

carried out on similar equipment available in the U.K., before reaching their decision.

Manufacturers who were already in production with new cameras were invited to submit equipment to A.B.C. Television, who made a series of far-reaching performance tests before reaching their decision. This is believed to be the first occasion upon which the latest cameras made by the various British manufacturers have been tested in turn under studio conditions prior to an order being placed.

**Marconi Cameras for Poland, U.S.A. and Britain**

AN order for three Marconi Mark IV television camera channels and ancillary equipment

for the Warsaw studios has been placed by Elektrim, the official Polish import and export organisation for electrical products. These cameras will operate to O.I.R. standards (625 lines, 50 fields, 8Mc/s channel) which are the same as in use in the U.S.S.R. The television station at Katowice, the biggest in Poland, is entirely Marconi-equipped.

Other recent orders for Mark IV camera channels include ten more for the Ampex Corporation of America, and two for Tyne Tees Television Ltd., the programme contractors to the Independent Television Authority for the North-East of England. It is understood that these latter two cameras will be incorporated in a small mobile O.B. unit which will be used to augment the service provided by Tyne Tees Television Ltd.'s existing



The illustration above shows a Marconi Mark IV television camera channel on test. An order for three television camera channels and ancillary equipment for studios in Warsaw, Poland, has been placed by "Elektrim".



Marconi Outside Broadcast vehicles.

### Rank Equipment for BBC TV Centre

**S**PECIALLY designed optical and sound equipment has been supplied by Rank Precision Industries Ltd. for the new BBC Television Centre at the White City.

The Taylor, Taylor and Hobson Division has provided the optical system for the universal standards converter, developed by the BBC for the "link-up" between the European Broadcasting Union and for videotaping programmes for use overseas. This Division has also supplied a range of television camera lenses, including eight studio zooms (Varotal II), three Remote Control Servo zooms and a range of fixed focus lenses for Image Orthicon and Vidicon cameras.

The G.B.-Kalee Division has completely redesigned existing magnetic soundtrack reproducing equipment for telecine operation. The film spooling capacity of each machine has been increased to 3,000ft, equivalent to a playing time of approximately 33 minutes per run. High speed rewinding in either direction has also been included.

### Caldbeck (Carlisle) ITV Station

**T**HE contract for the supply and installation of the supply and installation of the Independent Television Authority's new station to serve the Carlisle area has been awarded to Marconi's.

The station will be sited at Caldbeck, near Carlisle. It will comprise two 4kW Band III vision transmitters, two 1kW sound transmitters, programme input equipment and combining units. The mast and aerial system is also being supplied by Marconi's. The mast will be 1,000ft high, triangular in cross-section. A horizontally polarised sixteen-stack (twin-eight) quadrant aerial will be used, with one vision and one sound transmitter feeding into all sixteen stacks. Should occasion demand, the combined outputs of one vision and one sound transmitter could be fed into eight stacks, with the remaining pair similarly feeding the other eight to provide parallel operation, but at present this procedure is not envisaged by the Independent Television

Authority. The effective radiated power in the direction of maximum propagation will exceed 100kW.

### Studio Five

**T**HE most advanced television studio in the world—Associated Redifusion's "Studio Five"—has been equipped with the 4½in.

E.M.I. at the Bournemouth R.T.R.A. Conference.

During the demonstration, successful experiments were carried out in sending colour over the system. It was stressed that this was not to suggest that colour transmissions are imminent or even contemplated but the demonstration was carried out to show that

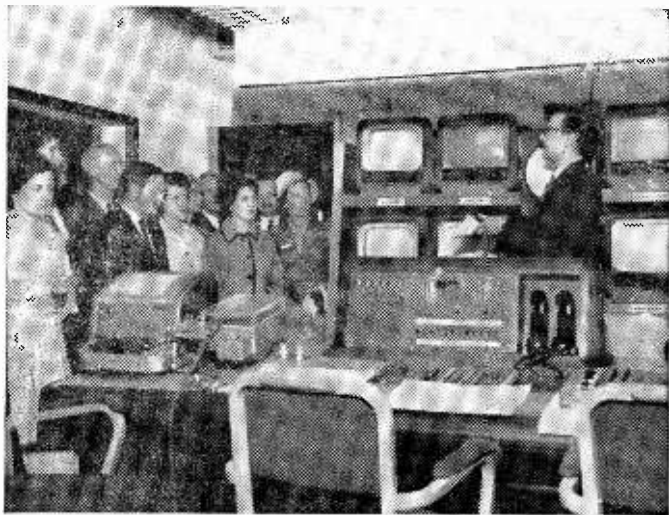

Architects attending the Royal Institute of British Architects' annual conference in Manchester recently, toured Granada's TV centre. Here a party of visitors are being shown over the Continuity Control Room. The Granada Building was one of the "Top Ten" post-war buildings in Manchester that the architects were recommended to see.

Image Orthicon camera tubes developed and manufactured by the English Electric Valve Co. Ltd. at its new factory at Chelmsford, Essex.

The increasing use of videotape recording, both as a means of storing topical events for future use and to allow more efficient utilisation of acting personnel, depends almost entirely on the high picture quality of the 4½in. Image Orthicon for its universal acceptability. The wide employment of the 4½in. Image Orthicon Camera/Ampex Recorder combination, in the U.S.A. and Great Britain, is evidence of this.

### Community TV System

**A**CONDENSED working set-up comprising headend equipment, cable and three intermediate amplifiers supplying, from aerial and camera sources, six TV channels and four VHF programmes, was demonstrated by

E.M.I. Community TV systems being installed today will also handle colour when it comes. The distribution system consists of a single coaxial cable which carries all the programmes, including colour, and the amplifiers are fitted into the cable network at intervals to ensure that the programmes are kept at an adequate level at every point throughout the system.

Each amplifier has several valves effectively operating in parallel which means that transmission will not be affected even though valves may have failed in the course of operation.

### Dutch TV

**T**HE newly-formed foundation of Cooperatieve Vereniging Co-TV has published a plan for the setting up of a second television network in Holland, to be part financed by advertising revenue. The programme would be independent of the existing television network in Holland.

# Servicing Television Receivers

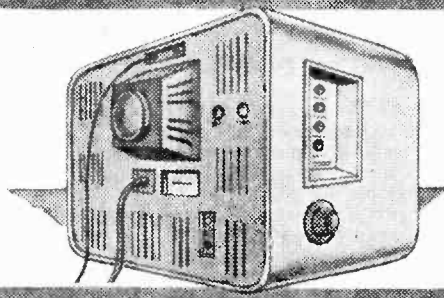

No. 58—THE FERRANTI 21K6, 21K5.

By L. Lawry-Johns

**T**HIS receiver is a 21in. console model with a Mullard MW53-80 tube, similar in many respects to the 14T6 and 17T6 range and this article will be found to apply in several instances to these receivers as well. Most of the faults which occur are due to valve failure and in general, the model gives very little trouble.

The turret contacts give the usual occasional bout of uncertain switching but this trouble is not confined to any particular make of set. The instructions given for one will equally apply to another and the writer finds that a thorough clean of all the biscuit studs and springs and a light application of "Electrolube" gives lasting service and often increased gain. The springs should not be adjusted unless they have already been tampered with. Attempted adjustment of the bow of the springs often results in permanent distortion, a new tuner unit, or at least a new bank of springs which are no joke to fit.

## A Common Fault

Still dealing with the tuner unit, a fairly regular trouble is the sudden loss of Band III signals, although the Band I (BBC) may still be perfect. When this is encountered, and the switch is working properly, a new PCF80 in the V2 position will nearly always put matters right. Complete loss of signals, Band I as well as Band III, often occurs as the result of a defect in this valve (V2). In this event, the PCC84 (V1) may equally be responsible, as could V3 but usually either the PCF80 or the PCC84 will be found at fault.

A misleading fault sometimes shows an inability to control the contrast (21K5) or sensitivity (21K6). This is usually accompanied by a ragged or grainy picture. Normally, the PCC84 will be found at fault with a grid-cathode short in the first section.

## Loss of Gain

Check tuner valves as above and then check the resistors in the tuner (having ensured that the aerial is in order) as the 130k resistors to the PCC84 second section control grid often change value as does the 220k to the screen of the PCF80. When a resistor is found completely burned

out in the tuner, before replacing, check the PCF80 for internal shorts and the decoupling capacitors, 1000pF lead-through and the 3,000pF (0.003 $\mu$ F). This is when the burned resistor is the 100 $\Omega$  main H.T. feed. The 1,000 $\Omega$  feed to the PCC84 will rarely be found overheating.

## Picture Faults

Turning now to the main deck we may consider the causes of *no picture, no raster*. The first test to make is that for EHT and here the characteristic whistle of the line timebase can tell us much. If the whistle is smooth and normal, EHT will almost certainly be present at the top cap of the EY86 (V16) and if the heater of this valve is not glowing, it can reasonably be assumed that it is o.c. and a replacement EY86 will no doubt put things right. If the heater is glowing however, EHT is probably present at the tube and the fault will be elsewhere. Check the setting of the ion trap magnet on the tube neck and the tube base voltages. These figures are an approximate guide; pin 2, 0-180V depending upon the brilliance setting;

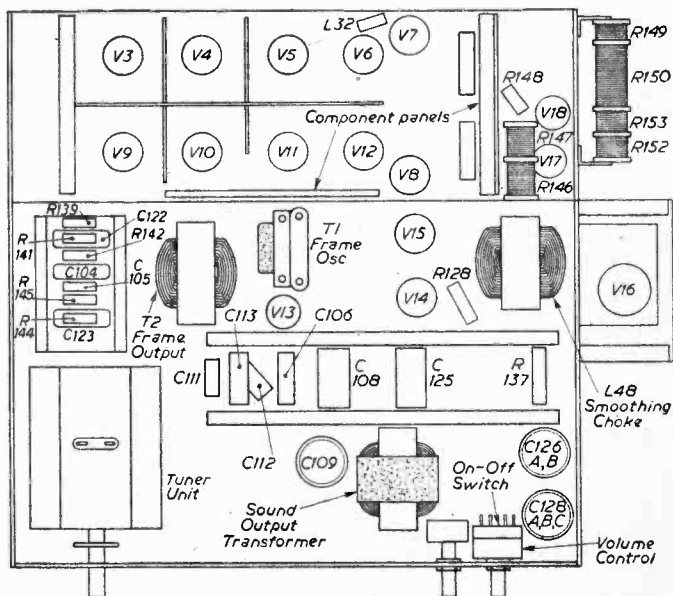

Fig. 1.—Simplified underchassis view

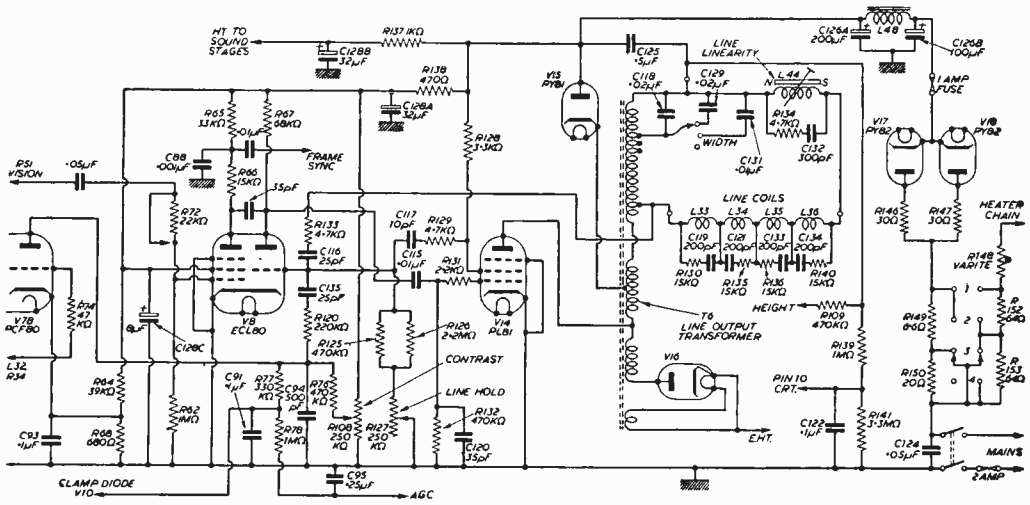

Fig. 2—Sync separator, line timebase and power supply.

pin 11, 170V depending upon the signal input; pin 10, very approximately 400V depending upon the meter used; pin 7, about 180V. The heater voltage dropped across pins 1 and 12 should be near the rated figure of 6.3V.

In the majority of cases, however, the EHT will not be present and, except for the previously mentioned EY86 heater failure, the line whistle will be absent or abnormal. Where it is absent, the PL81 should be observed. If this appears overheated (plate red hot), check the valve itself (V14) and if this is in order, check V8 (ECL80) but first remove the anode clip of the CRT or the top cap of the EY86 to ensure that an EHT short is not responsible for the lack of oscillation. It is interesting to note that the EHT lead to the CRT is screened and that this screening is bonded to chassis. Although the writer has never known this cable to break down, it could well do so and thus present similar symptoms to a short in the tube. This is why it is better to remove the top cap of the EY86, as this action cuts out the EY86 circuit completely. If removal of this cap restores normal conditions in the PL81 and a hefty spark at the unconnected cap, either the EY86 is shorted (most likely), the cable is defective or the tube has an inter-electrode short.

In all probability, however, removal of the EY86 top cap will not alter the fault conditions and the PL81, ECL80 or an associated component will be found defective.

When the timebase whistle is audible, but subdued or sounds strained, carry out the above tests of removal of the EY86 top cap, etc. and note the change of pitch, if any. If there is a difference, check the EY86, cable and tube as before. If there is no difference, check the PL81, PY81, capacitors C125, C118, etc. and R128. Shorted turns in the line output transformer will produce various symptoms depending upon the location of the short and when the valves, capacitors and other components have been checked and the line scanning coils disconnected for test, the line output transformer may reasonably be suspected. Regarding the scanning coils, a fairly frequent fault is a breakdown of insulation between the line coils and the core. Although replacement is an obvious

solution it has been found that the coils can be re-wrapped fairly easily and where this has been done, no further trouble has been experienced.

**Lack of Width**

The PL81 is again the principal suspect. If a replacement does not give any better result, check R128 and the H.T. voltage. If the voltage is low at the 1A fuse, say under 200, check both V17 and V18 as one of these PY82 valves may be low thus throwing all the load on to the other. Some H.T. figures may be valuable and the following are examples of average conditions for a 230V input. H.T. current at the 1A fuse—340mA. This is taken with the fuse removed and the meter, switched to, say, the 500mA range clipped across the holder.

The voltage at the fuse should be about 235, the smoothed H.T. voltage at L48-C126A should be about 220. Voltage at pin 8 of the PL81 should be 160, i.e. there is a voltage drop of 60 across R128.

**Striations**

Vertical rulings down the left side of the screen accompanied by compression on this side should direct attention to R134 (4.7k) which may be found open-circuited.

Fainter rulings should draw attention to the components across the line scanning coils, namely the 15k resistors and the 200pF capacitors.

**Width Control**

On the rear of the line output section is the linearity control slider which expands and contracts one side of the picture in relation to the other, this being on the right of the section, whilst to the left of this are three pins or studs, either of which may be selected to provide the desired width. The two pins to the left are for connection of the line scanning coils only.

(To be continued)

The article on "Feeder Cables" which began last month has been held over owing to pressure on space, and will be concluded in the September issue.

# Add-on Sound

## Unit

By "Electron"

*(Continued from page 526 of the July issue)*

### INSTALLING THE AMPLIFIER

**N**O detailed information has been given on chassis dimensions; the most accurate drilling details can give rise to difficulty if the parts employed are not identical with those specified. Before any wiring is attempted all the necessary holes in the chassis should be made. The positions can be determined by placing the components on top of the chassis in the approximate positions which they will occupy and marking the necessary holes. The main under-chassis wiring of the amplifier is given in Fig. 4. It is relatively simple and therefore the complete wiring is not given in the diagram. Wiring should be carried out with careful reference to the circuit diagram so that unnecessary mistakes do not occur. Most of the components are mounted on an 8-way group board near the valveholder for V1. The wiring for this group board was given in detail in Fig. 3. It will be found that the

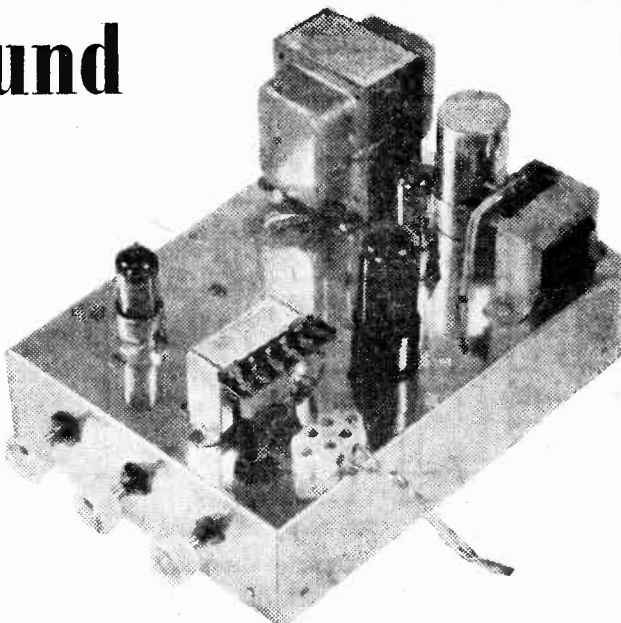

**The complete amplifier.**

use of a group board instead of the usual method of suspending the wiring from the various tags of valveholders, etc., will give a much more professional appearance. Another way in which the wiring can be made to look neater is to employ yellow

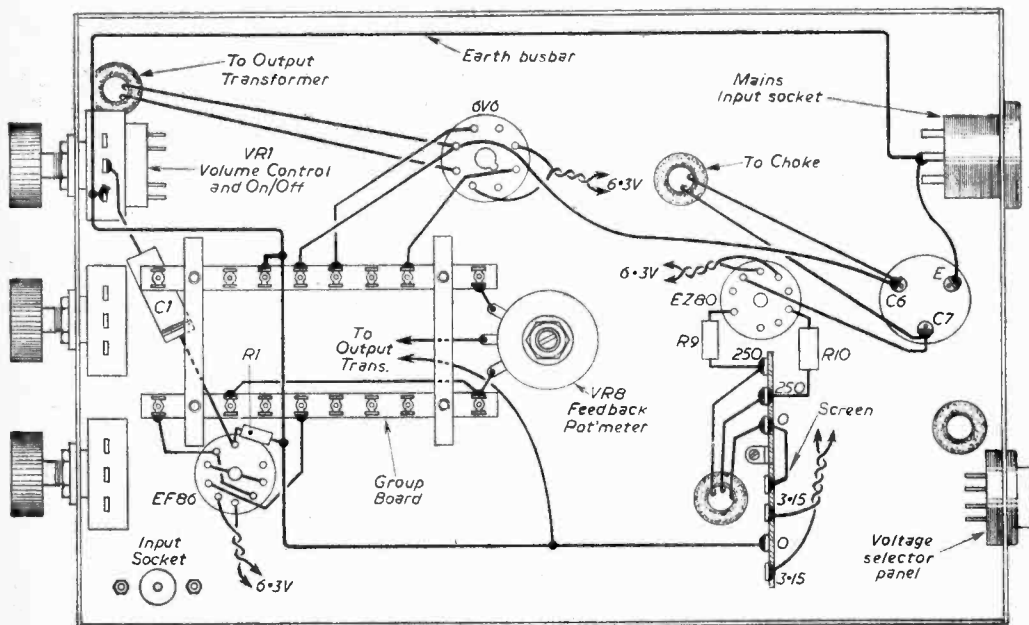

**Fig. 4.**—Main underchassis wiring (the earth bus-bar may be connected to chassis from point "x" at the input unless the receiver with which the amplifier is to be used has a live chassis. In this case the bus-bar may only be connected to chassis via a 0.02 $\mu$ F condenser (750VW A.C.).

Imm sleeving throughout the unit, wiring up with 22s.w.g. bare tinned copper wire, cutting the sleeving to length as required. However, for parts of the circuit which are at high voltages—wires carrying mains and H.T.—plastic covered copper wire may be used with advantage (this is obtainable cheaply from multiple stores). Two colours can be used where it is necessary to distinguish between two wires such as in the speaker output circuit and in the mains wiring. Heater wiring can be made using sleeved connections but, as the illustrations show, in order to keep the hum level low all heater wires should be tightly twisted and kept well towards the corners of the chassis particularly the wiring associated with V1.

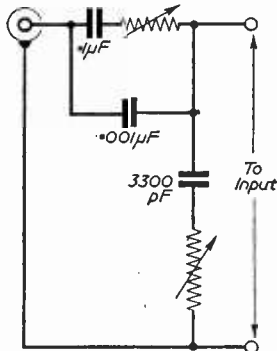

**Fig. 5.**—A tone control circuit. The variable resistors may have values of 100k or use may be made of available potentiometers.

Heater wiring can be made using sleeved connections but, as the illustrations show, in order to keep the hum level low all heater wires should be tightly twisted and kept well towards the corners of the chassis particularly the wiring associated with V1.

**Earth Busbar**

As in all high quality amplifier practice, no connections are made to chassis if it is desired to earth particular components as the circuit dictates. Instead, an earth bus-bar of 16 or 18s.w.g. tinned copper wire is used. This wire runs from the earth pin of the three pin mains input socket along to the earthy side of the volume control to a tag on the group board and from there to the centre tap of the 6.3V heater winding on the 7-way tag strip near the rectifier valve. All earth connections are made to this bus-bar and not to chassis. The bus-bar is however connected to chassis at one point and one point only. A small tag is inserted under the fixing nut for the coaxial input socket and a length of 16s.w.g. tinned copper wire is used to connect the bus-bar to this point. Good soldering is essential.

Most of the large value condensers used consist of two pieces of foil separated by insulating material and the outer of the two foils is indicated

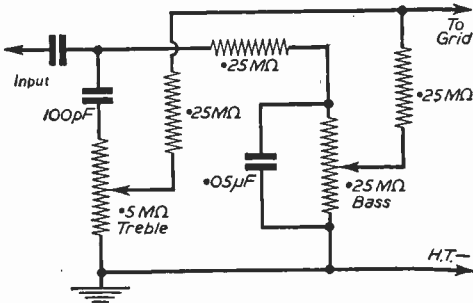
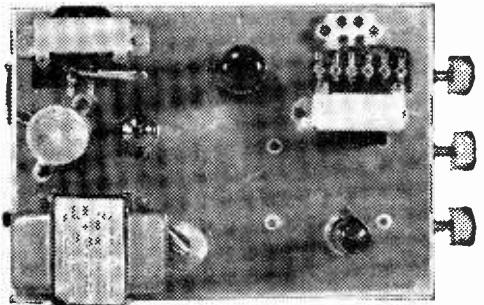

**Fig. 6.**—Another tone control circuit—values may be modified if required.

**Modifications for A.C./D.C. Technique**

As we often state in our pages, very great care must be taken when working with A.C./D.C. receivers, especially when extra units are added. The following precautions are therefore essential. A non-reversible mains plug must be employed so that the chassis of the receiver is always connected to neutral of the mains. All the metal-work of the added unit must be concealed so that it is quite impossible for any part of it to be touched. The input socket can be abandoned with advantage as the earthy side of the lead from the TV receiver must necessarily be connected to the receiver chassis. The bus-bar in the amplifier is NOT connected to the chassis except by way of a 0.02 μF condenser (750V A.C.) working and the chassis must not be earthed. The bus-bar must no longer be connected to the earth pin of the mains input socket but must be carefully isolated. Although the earth lead could be connected to chassis once an isolating capacitor is used, it is usually unnecessary and to a certain degree unwise.

on the body of the condenser by black rings. These markings are indicated in Fig. 4.



**Plan view of the amplifier.**

**Tone Controls**

Tone controls may be added before the input circuit of the amplifier and suggested circuits are given in Figs. 5 and 6, but, unless top or bass cut is particularly desired, it is best, in my opinion, to omit tone controls as often the only effect is to provide two more variable controls to perplex members of the household.

It will be noted that the resistor in the feedback loop of the amplifier (VR8) is made variable so that the degree of feedback can be altered according to preference. As the value of this resistor is decreased, so the tone of the amplifier tends to develop increased bass and should give adequate tone control.

**Connections**

In most television receivers the output from the sound detector (which is generally a germanium diode) is fed via the volume control direct to the sound output valve. Thus, adequate signal should be available at this point for operating the new amplifier. No matter what the method of detection,

*(Continued on page 566)*

# Frame Troubles Explained

LINEARITY, POOR LOCKING, PICTURE BOUNCE, ETC.

By G. J. King

**F**AULTS in the frame timebase of any television receiver can cause many symptoms, such as insufficient height, picture rolling, erratic locking, picture bounce or judder, line pairing and lack of interlace, intermittent or total collapse of scan producing a bright horizontal line etc. Faults causing a total collapse of scan are not usually difficult to establish, since only two or three stages are involved, but faults causing less definite or intermittent symptoms often pose quite a problem, and it is invariably necessary to substitute suspect components on a trial-and-error basis.

### Total Collapse of Scan

The resulting horizontal line would be likely to burn a permanent line in the picture tube screen if the brightness were left at full intensity. While investigating this symptom, therefore, the brightness control should be turned right back until the line is only just visible. The first thing to do is to establish whether the trouble lies in the frame oscillator or amplifier. Modern receivers often use triode-pentode valves in the timebase circuits, such a circuit being shown in Fig. 1 (Decca DM4/C).

The triode of V8 and the triode of V15 are back-coupled in the form of a multivibrator. The pentode of V15 is the frame amplifier coupled to the multi-

vibrator through C56, while the pentode of V8 is the sync separator, feeding frame sync pulses to the multivibrator through C54. One way of checking the frame amplifier, output transformer, T2, and the frame coils is by coupling the control grid of V15 pentode to the heater line, via 0.1  $\mu$ F capacitor C, as shown in the circuit. If all is well here, the horizontal line will open out into a form of distorted raster, possibly with inadequate height, but in order to see this properly, the brightness control will need to be advanced slightly.

### Voltage Readings

If there is no response, then a few voltage readings should be taken around V15 pentode. If the cathode is well below 12V, but about 200V is present at both anode and screen, the valve is almost certainly in need of replacement, being low in emission. Open-circuit of the primary section of the frame auto-transformer, T2, would show up as no volts on the anode, but open-circuit of the secondary section would not give this effect as current would flow through the frame coils to the valve anode in this type of circuit. This should be remembered. This fault may, or may not, cause total frame collapse, depending on the transformer and frame coils, but in any event the height would be very much reduced and the raster or picture highly distorted.

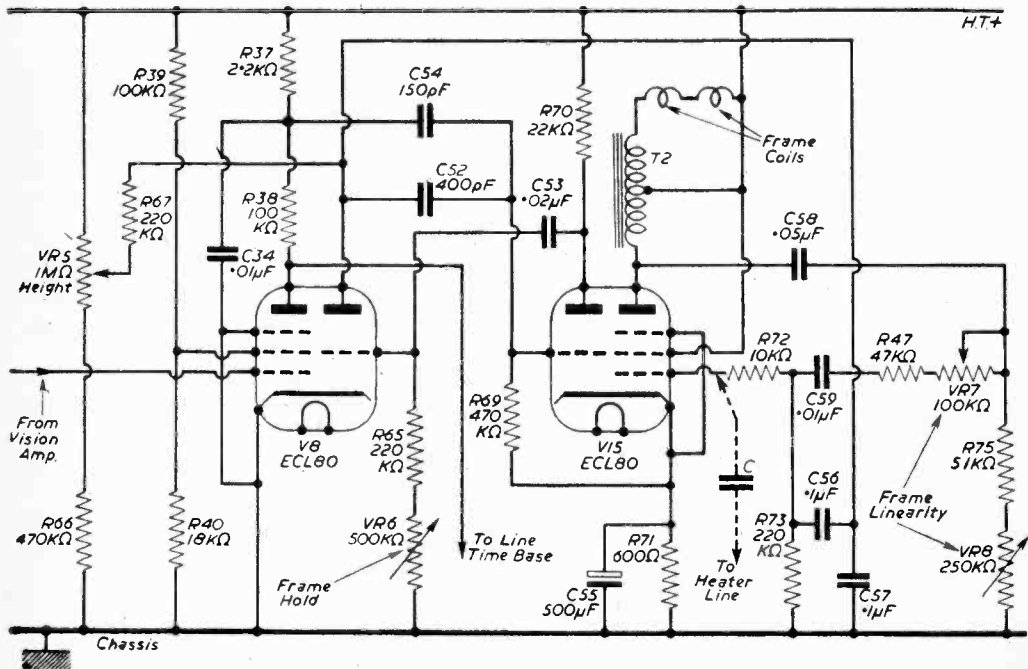

Fig. 1.—Multivibrator frame oscillator and pentode frame amplifier, with the pentode of V8 forming the sync separator (Decca DM4/C).

If there is response from the test described previously, the frame oscillator (multivibrator) would be responsible or the coupling between the oscillator and amplifier. Thus, C56 would be a suspect. This sometimes becomes intermittent and causes intermittent frame collapse. Applying pressure to the capacitor with a screwdriver blade or pulling lightly against the lead-out wires while the set is working often reveals an intermittent fault. On the other hand, a substitution test may be needed. Care should be taken when removing the suspected component, for it can easily happen that the strain of being removed and replaced will part one of the lead-out wires from the internal foil, and thus introduce an additional fault. Thermal damage due to unsoldering and resoldering is not uncommon, and this applies both to capacitors and high value miniature resistors.

If the coupling is in order, attention should be directed to the two triodes in the multivibrator and their associated components. Anode feed resistors are always suspect, as also are variable potentiometers carrying H.T. current, such as VR5. Fairly high A.F. voltages are developed across the coupling condensers C52 and C53, so these should also be investigated in multivibrators. A leak in the sync coupler, C54, may also be sufficient to put the oscillator out of action.

#### **Severe Cramping at Bottom of Picture**

This fault often occurs after the set has been operating for an hour or so, and often leads one to suspect one of the valves, but replacement does not cure the trouble. Where no apparent alteration in component value can be detected, suspect shorting turns in the frame output transformer. However, should the symptom be accompanied by slight cramping at the top of the picture, check R71, in V15 cathode circuit, for increase in value.

A large increase in the value of R71 may lead to the scan being considerably reduced, and the same trouble may also occur due to the cathode bypass capacitor, C55, going open-circuit. The vertical scan in this case will be reduced to approximately  $3\frac{1}{2}$  in. with the height control at maximum.

#### **Frame Roll**

Frame roll after the set has been working for an hour or so sometimes indicates a fault in V8 or V15, which can only be proved conclusively by substitution. However, in poor signal areas, and where the trouble is persistent and appears to have no origin, improved lock can be secured by the following modifications. Increase R37 (2.2k) to 4.7k and decrease R38 (100k) to 60k. This puts the frame sync tap-off point lower down the potential divider in the sync separator anode circuit, and thus results in a larger frame sync pulse being applied to the oscillator.

Inadequate hold, or complete absence of hold, should also lead to the checking of the frame sync coupling capacitor (C54 in Fig. 1). In other receivers, interlace filter circuits are often employed and make use of small metal rectifiers or germanium diodes. These should immediately come under investigation as they are invariably responsible for the trouble. This applies to Pye and similar receivers. Other sets, such as Ferranti, etc., use valve diodes. These do not give so much trouble, but they do feature high value resistors and coupling capacitors carrying frame sync signal, and these often alter in value or go open-circuit and cause the same trouble.

The sync separator should also be examined in persistent cases, and it is as well to bear in mind that the sync separator could be in fault in spite of a solid line lock. This applies also to a lesser extent to the video amplifier stage. The low frequency response must be well maintained to preserve a good frame sync waveform, which means that the video amplifier cathode bypass capacitor must be of high efficiency and of correct value.

Low value electrolytic smoothing capacitors can produce impaired line and frame lock, even though the hum level on sound (and picture) appears to be normal. This is also a fault well worth having in mind when all else seems to be in order.

In circuits using a frame blocking oscillator, poor insulation between the windings of the blocking oscillator transformer can give rise to poor frame hold without affecting the frame scan noticeably. When this trouble is responsible, however, poor frame linearity may also be an attendant symptom.

#### **Linearity Troubles**

A rather interesting frame linearity fault, consisting of reduced height, hunt bar on picture, and the bottom half of picture brighter than the top half, sometimes occurs on sets which feature a frame flyback suppression circuit, notably the Bush TV53 and TV62 series. These sets use an 820pF capacitor located on the tube base to couple the frame flyback pulse to the tube grid to secure blackout of flyback lines. If this capacitor has a tendency to leak, then the symptoms described occur to an extent depending on the amount of leakage. When this fault is present, the brightness control tends to alter the height of the picture more than usual.

On the same receivers, a foldover at the top of the picture, with flyback lines in evidence at the top, is often caused by open-circuit of the 1100pF capacitor

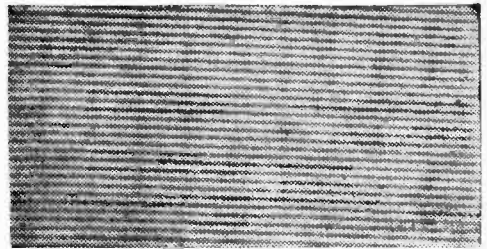

An illustration of perfect interlace on a TV picture.

connected between one side of the frame linearity control and a 47k resistor, which is returned to chassis. This is mounted on the top of the frame output transformer.

In Ekco T231 series receivers, a white line may occur across the centre of the screen, this being very thin and the result of bunching lines. In most cases it is caused by a spurious oscillation developing in the frame amplifier owing to a fault in the 20P5 frame output valve. The valve should be checked by substitution, or should definitely be replaced if the voltage between its cathode and chassis has risen from the normal 9-10 to a figure approaching 20.

(Continued on page 571)

# Common TV Faults

## MAINS VOLTAGE VARIATIONS AND MULTIPATH INTERFERENCE

By G. Court

**E**VEN a perfect set will only operate correctly and give the good picture that is expected when it is in receipt of a good aerial signal and the required power voltage. Modern sets are working fairly hard to produce a large picture with the least distortion, and these conditions cannot be met if the applied mains voltage is below the required value. All receivers have a mains voltage tapping which allows adjustment over a range of mains voltages which are likely to be present in various parts of the country.

### Mains Voltage

On setting up the receiver initially, the dealer should always ensure that this adjustment is set to suit the local mains voltage. The experimenter should do likewise whenever a receiver is connected to his mains supply. Unfortunately, it is often taken for

accordingly, but the supply is in fact 230V, the receiver will be underrun by 10V. If the set is fairly new, the pre-set controls could be adjusted to mask any resulting shortcomings to the picture. It may possibly be found that the picture width control (if one is fitted) is almost at maximum and that the height and hold controls are towards the end of their range. Nevertheless, a reasonable Test Card "C" may be obtained, though a critical viewer may observe undue non-linearity at the right- and left-hand sides of the picture.

If the set is well worn, adjustment of the pre-sets may not hide the error; the full width of the picture may not be forthcoming even when the width control is set to maximum, and the picture height may be similarly affected. The picture may not be as bright as it should be and the focus may be impaired, particularly when the brightness control is turned up in order to try to brighten the picture. If the tube is low in emission, then the image may tend to turn negative and the other symptoms of a low emission tube will be well in evidence. Usually, however, it is the width (and possibly brightness) of the picture which is first affected by underrunning. This is because the line timebase amplifier and EHT system is the hardest run section of the receiver and any power starvation will show up here first.

### Check Power Voltage

If there is any doubt about the mains, a voltage check should be made, and reliance should not be based on the voltage as may be marked on the electricity meter or switch gear. If a suitable voltmeter is not to hand, and there is reason to suspect that the voltage is not as local opinion would indicate, the local dealer or electricity board should provide the right answer. When this is known, the mains tapping of the receiver should be adjusted as accurately as possible to correspond.

### Set Fault

If now the receiver does not function properly, then there is every likelihood that the receiver has been overrun previously and the valves and tube have suffered. In this event, it is not a good idea to put the main tapping back to its original lower setting, as damage may occur to other parts of the set as well. The faulty components should be traced and replaced. If the set has been underrun for any appreciable time, the correct voltage should give a marked improvement in overall performance.

### Voltage Variation

A variation of mains voltage often occurs throughout the day and night. In some places, the local house wiring and network may be inadequate to handle increased power without producing a drop in voltage. Thus, during peak electricity hours the voltage may show a marked drop. Reports indicate that this happens primarily during the evening (and on Sunday mornings, though TV reception is not so

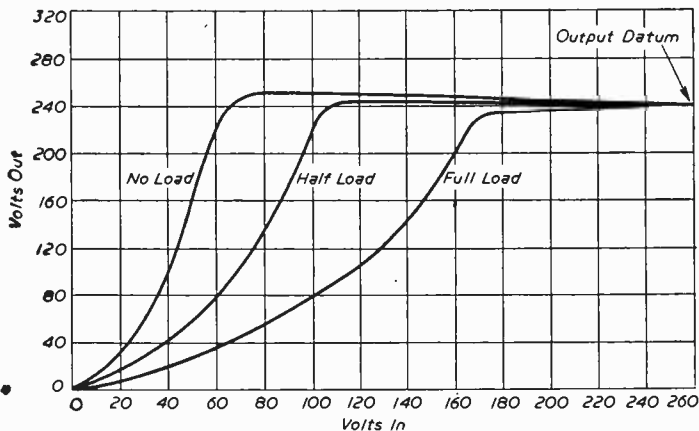

Fig. 1.—Series of curves showing how the output voltage of a constant voltage transformer remains constant over a range of input voltages under different conditions of loading.

granted that the mains voltage is constant throughout the town. This does not always follow and there may be as much as 15V difference from one part of the town to another. With rapid local housing development this state of affairs is often aggravated and mains distribution transformers invariably have to be installed to cater for the extra load, and as a consequence a rise and fall of voltage occurs throughout the local network. Needless to say, these problems are being dealt with as quickly as possible by the Electricity Authority, but the conditions described do in fact exist today in various parts of the country.

If it is assumed that the supply voltage is, say, 240V and the receiver mains adjustment is set



likely to be affected then), especially in the winter months when many cookers and electrical appliances are brought into service after business hours. As much as 10 to 15V can be lost owing to a large current drain, and this, as previously described, can seriously impair the performance of the receiver. If viewing is taking place during a period of peak demand, then the receiver may be working all right to start with, but gradually develop the symptoms described as the voltage falls, and revert to normal as the peak passes. Unless one is aware of this trouble, it may well be attributed to a set fault, as, indeed, there are faults which could occur in the set to give exactly the same symptoms.

### Constant Voltage

When the voltage drops and the set performance falls off the mains adjustment can be reset to the lower voltage and all will be well. Unfortunately, this is a dangerous practice as the voltage is likely to rise to normal without indication, and then the set is overrun. Having a voltmeter permanently connected across the mains supply helps here, but it is not very pleasant having one eye on the picture and the other on the voltmeter. Some automatic device is necessary to iron out such voltage variations.

There is no simple and cheap way of obtaining this "automation." The most practical way of obtaining it, however, is by the use of a constant voltage transformer connected between the power point and the television receiver. Such a transformer capable of delivering just about enough power to operate a small set costs in the region of £8. This will accept an input in the range of 190-260V and give a constant output at 220V, 240V or any other voltage that may be needed. A transformer with an output of 240V is suitable for most sets, for then the voltage adjustment can be set to correspond to the transformer's output voltage.

This type of transformer operates on the saturated core principle. The residual primary current causes the core to become magnetically saturated. Thus, any variation in primary current due to an input voltage change will not alter the magnetic conditions of the core, and consequently will not alter the voltage induced in the secondary winding within the operating limits of the transformer. Typical operating curves of a constant voltage transformer are given in Fig. 1.

### Multipath Interference

Multipath interference refers to the poor picture quality and ghosting effects which occur as the result of the aerial picking up reflected signals in addition to the direct signal. Since the reflected signal arrives

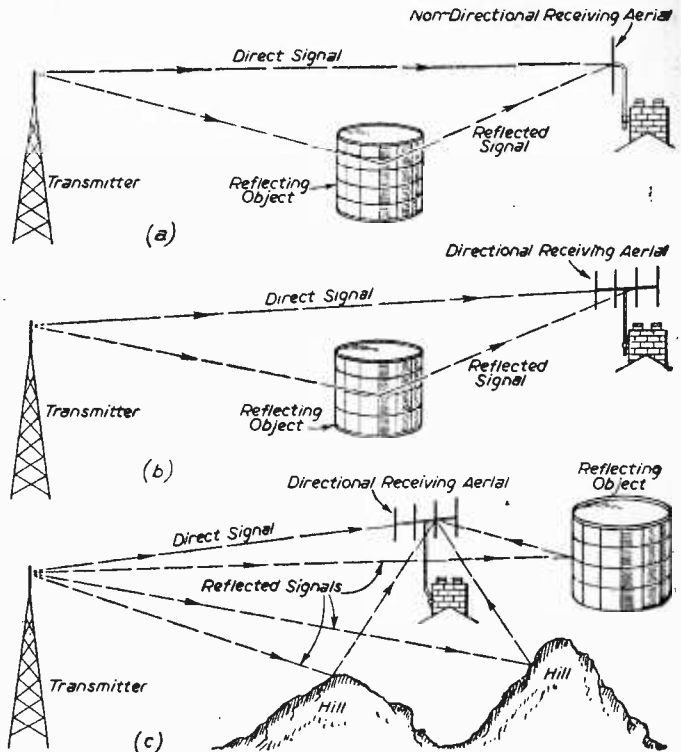

Fig. 2.—(a) Signal reflection in which the non-directional receiving aerial responds equally to both direct and reflected signals. (b) the reflection is eliminated by the use of a directional aerial. Even multiple reflections can often be suppressed by a carefully orientated directional aerial (c).

at the aerial a very small fraction of a second after the direct signal a secondary picture is produced slightly to the right of the real picture. This secondary picture is often called a "ghost." The displacement between the real picture and the ghost depends on the time between arrival of the direct signal and the reflected signal. If the time is very small, then the ghost may be very close to the real picture and detract from the overall picture quality. If the time interval is relatively large, the ghost may appear an inch or so away from the real picture. Multiple reflections will give rise to multiple ghosts, one after the other right across the picture. Owing to phase change of the reflected signal, some ghosts may appear as negatives of the real picture. In severe cases, the horizontal hold may be badly affected, and the set may have difficulty in deciding on which picture to lock.

In Fig. 2(a) is shown a simple case of signal reflection, in which the reflected signal may cause an almost equal response in the non-directional aerial as the direct signal, thereby giving rise to a ghost almost as intense as the real picture. The reason for this, of course, is that the aerial, being non-directional, picks up signals equally in all directions.

(Continued on page 578)

# Replacing C.R. Tubes—10

SOBELL RECEIVERS

By H. Peters

## General notes

SEVERAL common features are carried throughout the Sobell range which make the operation of changing the tube easier to follow. In all cases a CR Tube with a 6.3V 0.3A heater is employed, and the chassis is connected directly to the mains and may be live. In general the tube is clamped to the chassis around the front of the bowl, and withdraws with the chassis when unboxed.

*Model TS17 covering T346, T176, T176C, T176LC, T347, and the earlier range T145, T175, T175C, T175LC, TRG 175*

## Unboxing

Remove cabinet back and pull off front knobs. Remove the channel selector and fine tuner knobs. Unscrew the plastic escutcheon on the cabinet side and the cover plate beneath the chassis. This is screwed at the front and back and slides out through a slot.

Remove the four fixing bolts beneath the chassis. This is easiest performed with the chassis upright and overhanging the edge of the bench so that a pair of the bolts protrude. When these have been withdrawn, the set is turned round and the other pair removed. If the chassis is unbolted in the conventional way, i.e., with the set on its side, all goes well until the last bolt is withdrawn when the chassis complete with tube descends on the side wall of the cabinet with a bump.

The chassis will then withdraw backwards from the cabinet, with the control panel being fed in through its hatch to lay on top of the I.F. stages. At this point the loudspeaker is best unplugged from the two-pin socket at the front of the set.

If it becomes stuck as the tuner spindle and the tube bowl attempt to pass through the rear framework it can be released by a shuffling motion if the back of the chassis is tilted slightly downwards to lower the top of the tube.

## Replacing the CR Tube

Discharge the EHT, remove the base, EHT cap and ion trap magnet, remove the metal clamp around the front of the tube, slacken the scancoils and ease the tube out forward. If there is a tendency to dislodge the rubber grommets which support the tube

neck as it is withdrawn, a light lubrication (grease, oil, or soap) will assist its easy removal.

Thoroughly clean all parts, including the inside of the cabinet, before reassembling in the reverse order, checking that the tube is seating well back on its cradle so as to avoid it touching the safety glass. Refit the loudspeaker plug as the chassis is refitted and take care not to trap the wire as the chassis moves into its resting position.

## Setting Up

Refit the ion trap magnet, CRT base and EHT connector, connect up and adjust the ion trap magnet for the brightest possible picture. Focus for the sharpest line structure by moving the lever which is over the focus gantry. Adjust the deflector coils for a picture free from tilt, and lock them in this position as far forward up the tube neck as possible, tightening the two brass thumbscrews at either side of the adjustment slot. Repeat these adjustments until no further improvement results, checking particularly that the ion trap magnet will not be able to move once the receiver has been boxed up. If it has lost its grip due to age, set it carefully and tape it up.

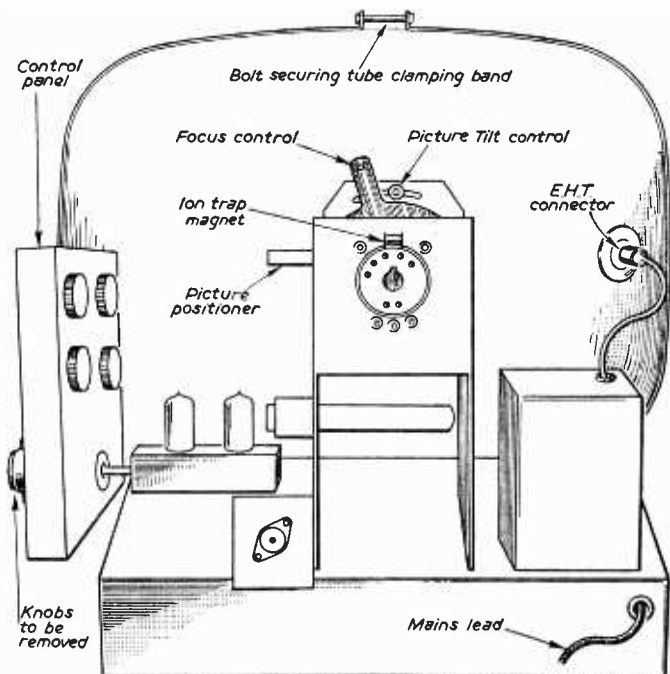

Fig. 1.—Rear view of model TS17.

### Screen Cleaning

On the TS17 the two bronze P.K. screws above the front control knobs are removed and the safety glass and mask may then be picked out. On other models it is necessary to unbox the chassis.

### Boosting (A.C.) only

Use a 6.3V plus boost low capacity isolating transformer, connecting its boosted secondary to pins 1 and 12 of the tube after the previous leads have been removed, shorted together and taped back. Mains for the boost transformer may be taken from between chassis and the thick pin of the voltage selector.

(A.C./D.C. alternative.) Connect a 5,000Ω 10W wirewound resistor from the thick pin of the voltage selector and the "hot" side of the tube heater. This is found by experiment. On the "cold" side of the heater colour of the tube will remain unchanged, on the "hot" side the tube heater will be seen to brighten slightly.

### Models T171, T21, T21LC, T21C, T171C, T347, T172, T22

These models are almost identical regarding CRT changing to the TS17 series. They have no front control knobs and it is therefore only necessary to remove the channel selector and fine tuner knobs and the side panel which is, as before, fed back in through its opening to lie on the I.F. strip as the chassis is withdrawn. The loudspeaker, which is mounted on the side will also need to be detached and this is done by removing the wing-nutted bolt at the back end, which permits the speaker sub-baffle assembly to slide backwards out of its mounting. Then, as with the TS17, the four chassis bolts beneath the cabinet are removed and the chassis withdrawn. The CRT is then removed by disconnecting the EHT cap and duodecal base, removing the ion trap magnet, slackening off the clamping band and withdrawing the tube carefully forward.

### Setting Up and Boosting.

See TS17.

### Focusing on 14 in. model T347

These receivers incorporate an electrostatically focused CR Tube and need no focus magnet. The focus electrode is connected to pin 6 on the tube, and on receivers with serial numbers over 18,000 a small pre-set resistor is wired across the CRT base. This may be adjusted with an insulated rod until optimum focus is reached. On early receivers, i.e., those with serial numbers below 18,000, a short flexible lead is soldered to pin 6 and this is touched on the other pins of the CRT base (except heater pin 12) until good focus is obtained. In addition to the various electrode voltages around the CRT base two resistors are added in series with the A1 lead to pin 10. A selection of voltages which vary between 0 and 450 in roughly 100V steps is thus available.

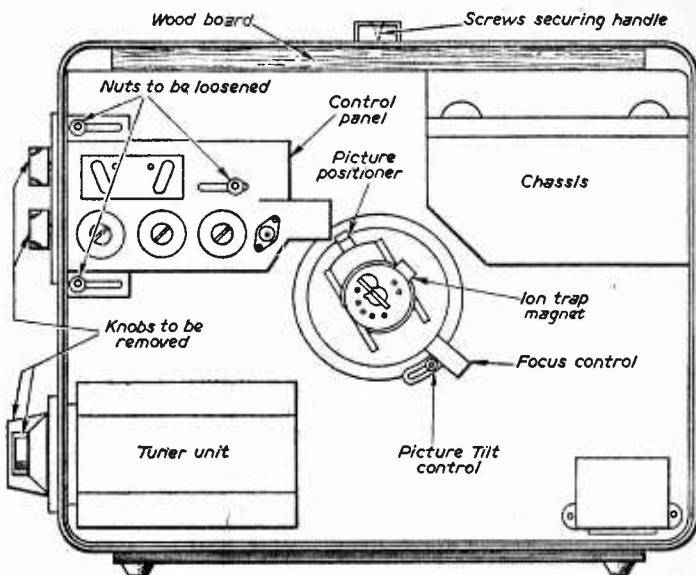

Fig. 2.—Rear view of model TPS147.

It has been the writer's experience that the focusing of these tubes is almost automatic and not at all critical. On only two occasions has it been necessary to use a tapping different from the one with which the receiver left the factory.

### TPS 147 and 147 DL

These 14in. transportable receivers have an upright chassis and once again, once the receiver has been unboxed the CRT removal is simple and obvious.

### Chassis Removal

Pull off the volume, on-off, channel selector and fine tuner knobs, loosen the two screws in the slots at the top and bottom of the panel containing the aerial socket, voltage adjustment, and three pre-set knobs. Loosen the nut on the same panel in the slot to the right of the voltage adjustment selector and slide the whole panel inwards so that the brightness and contrast knobs are inside the cabinet. Remove the two screws holding the handle. These are beneath a p.v.c. covering which should be carefully moved to one side to expose the screwhead. Remove the screws in the rear feet below the cabinet. Unscrew the plastic disc around the channel selector spindle. The chassis will then withdraw backwards from the case. It will be seen that the loudspeaker is mounted in a plywood baffle, and it is convenient to use this as a base for servicing, as by inverting the set upon it almost all of the receiver is readily accessible.

### To Replace the Tube

Disconnect the EHT cap and CRT base. Remove the ion trap and picture positioning magnets and lay these down away from each other, slacken off the clamping band around the tube bowl and remove the tube forward, having noted the relative position of the clamping band to the face of the tube to assist in reassembling. Clean thoroughly before reassembling in reverse order.

### Setting Up

Adjust the ion trap magnet for maximum brightness with a normal picture and then position the picture by means of the positioning magnet. This is similar to the ion trap magnet but is larger and further forward, being up against the deflector coils. Two directions of movement can be imparted to the raster, one by rotating the whole assembly and the other by turning the magnet in its cup. The adjustment of the positioning and ion trap magnets depend upon each other and so their adjustments should be repeated a number of times until no further improvement results. Focusing is carried out by means of the small pre-set resistor on the tube base connector which should be set for best overall focus on highlights.

### Boosting (A.C. only)

Use a 6.3V boost transformer and connect the secondary to pins 1 and 12 of the tube having removed the previous pair of wires and shorted them together. Mains for the transformer can be obtained from between chassis and the set side of the 1A fuse.

### Model TPS173, covering the T178 and T23

Note.—An easy-service chassis is used on this receiver. The top half of the main chassis hinges outwards giving access to both sides of the two printed panels simply by pulling sharply on the top edge at each side. This fact should be remembered when suitable hand-holds are being sought during dismantling.

### Chassis Removal

Remove the cabinet back and the plastic escutcheon over the controls. This swings out forward when the two turn-buckles have been rotated clear of the cabinet. Remove the CRT mask and window by unscrewing the two countersunk screws at the bottom, lifting the bottom outwards and then pulling the mask down and away from the cabinet. Remove the cardboard bottom and four fixing screws from the base of the cabinet. Remove the aerial panel (two 4B.A. nuts and bolts). Take out the two insulated thumbscrews holding the chassis and carrying handle to the cabinet and withdraw the chassis forward out of the cabinet.

When replacing the chassis in the cabinet, the two U-shaped cardboard packing washers fit between the chassis member and the top of the cabinet around the carrying handle screws. If, on withdrawal, the knobs on the control panel tend to catch on the cabinet side it is useful to note that the entire panel is spring loaded and can safely be compressed about half an inch.

## ADD-ON SOUND UNIT

(Continued from page 559)

It should be possible to disconnect the signal lead from the "top" of the volume control of the receiver and connect it to the input circuits of the amplifier. This adaptation is particularly easy where the receiver uses an isolating transformer in the power circuits. In A.C./D.C. sets certain precautions are necessary and are dealt with below.

Now that a separate amplifier is being used, naturally the former sound output valve is now left inoperative and at first sight it might be thought that it should be removed. However, removal of this valve reduces the H.T. drain and may affect the H.T. line voltage and possibly many circuit conditions. In A.C./D.C. receivers, removal

### C.R.T. Removal

Remove base, EHT connector, ion trap magnet and slacken deflector coils. Note the position of the tube bowl in relation to the clamp, slacken off clamp and withdraw tube forward. Clean all parts before reassembling.

### Setting Up

The ion trap should be adjusted for the brightest picture obtained with normal setting of the controls, and the focus resistor on the tube base should be set for best focus on highlights. The positioning device may be an "ion-trap" type magnet or else a pair of rotating plates behind the scancoils which can be moved independently to provide two areas of shift for the raster.

### Variations

Some wooden cased models using the same chassis do not have a detachable safety glass and the tube cradle and chassis therefore slide out backwards on unboxing. In other respects the tube change is similar.

### Models TPS180 covering the T278, T24, SC24, SC270 (see variations)

#### Warning 110deg Tubes

All the above receivers use a wide angle 110deg tube. It should be realized that the more the shape of a tube departs from the traditional goldfish bowl the greater are the stresses set up in the glass under high vacuum. The risk of implosion when handling is therefore theoretically greater than with earlier shapes of CRT.

### General

This range, like its predecessor, has been designed with a view to easy servicing. The whole of the main component chassis is held into the metal framework by two stout pegs at the bottom and two spring clips at the top so that by holding its top edge and pressing the thumbs against the main frame the entire unit will lift out backwards for easy servicing—see Fig. 3. In this condition the electrical connection to the main chassis is made by the black loudspeaker lead so that if the set is operated with this lead disconnected a potential corresponding to approximately half the EHT voltage will exist between the two frames. Although the foregoing is not exactly relevant to the CRT change, it is as well to know about it so as to avoid lifting the entire chassis out by holding the detachable portion.

(To be continued)

of the valve would put an open circuit in the heater chain. Although much depends on the individual receiver, for the most part, it is unwise to remove the valve. The grid of the valve can be connected to chassis so that its working conditions are stabilised. If, so far as H.T. drain is concerned, the valve may be removed, then if the set is of the A.C./D.C. type it will be necessary to use a shorting plug in the valveholder to preserve heater chain continuity.

### Loudspeaker

Little has been said about the loudspeaker system which is necessary with this amplifier, but it is hoped to give more definite information and possibly a more complicated and refined amplifier circuit in a future article.

# Every keen radio man must see it!

NOW COVERS RADIO-ASTRONOMY

**FREE** for 7 days  
AND WITHOUT OBLIGATION

The long-awaited New Edition of this practical engineering and servicing work is now ready for you. If you are a Radio Engineer, Technician, Mechanic, Instructor, Student or Keen Amateur, this great wealth of data will prove invaluable. Newest developments and techniques are included—from latest transistors to low noise micro-wave devices; from advances in quality reception to radio-astronomy and space probe communication. Be up-to-date by sending to-day for FREE EXAMINATION. This New Edition is of absorbing interest to you—*post coupon to-day!*

**PACKED WITH DATA FOR DAY-TO-DAY NEEDS—WRITTEN BY 50 SPECIALISTS**

Formulae. Calculations. Communication Theory, Electron Optics. Colour, Projection and Industrial T.V. Materials. Studio Equipment. Transmitter Power Plant. V.H.F. Transmitter-Receiver Equipment. Amateur Equipment. Waveguides. Receiver Design. Radio Links. Broadband Systems. Radio Navigation and Radar. Radio Astronomy and Satellite Communication. Valves. Cathode-Ray Tubes. Transistors. Crystal diodes. Resistors. Capacitors. Inductors. Transformers. Microphones. Gramophone Mechanisms. Loudspeakers. Interference. Recording. Measuring Instruments. Installation and Servicing. Ionospheric Forecasting. Units and Symbols. Developments, etc.

**SEE THESE PRACTICAL FEATURES**

Latest types of Transistors and their use ● Single-Sideband Transmitters ● V.H.F. Scatter and Meteor Burst Communication Systems ● Travelling Wave Tubes ● Radio Astronomy ● Modern Car Radio Receivers ● Stereophonic Reproduction and Recording Techniques ● T.V. and Radio—latest Practice in Receiver Installation and Servicing ● New Air Navigation Aids.

**Broadcasting · Communications · Navigation · Radar, etc.**

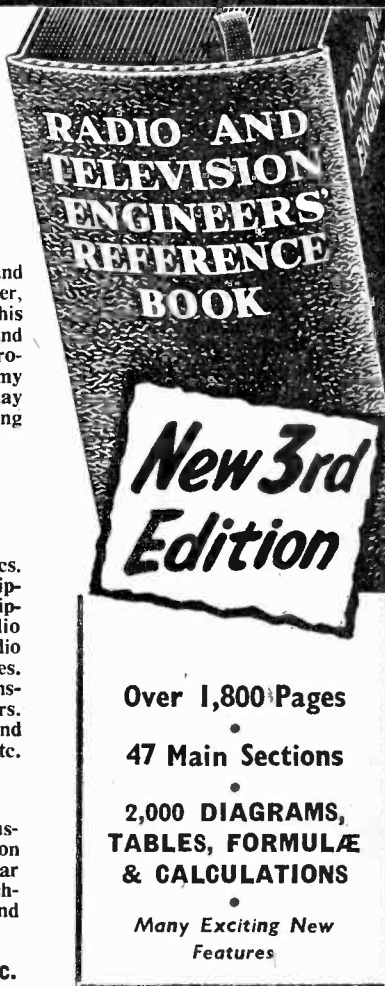

**JUDGE FOR YOURSELF**

*Post Now for 7-day Free Test!*

GEORGE NEWNES, LTD, 15-17, LONG ACRE, LONDON, W.C.2.

Please send me Newnes RADIO AND TELEVISION ENGINEERS' REFERENCE BOOK without obligation to purchase. I will either return the work within eight days or I will send the first payment of 5/- eight days after delivery, then ten monthly subscriptions of 10/-, until the sum of £5.5s. has been paid. Cash price within eight days is £5.

Name \_\_\_\_\_

Address \_\_\_\_\_

Occupation \_\_\_\_\_

Your Signature \_\_\_\_\_  
(Or your Parent signs if you are under 21)

Tick (✓) where applicable

HouseOWNER	<input type="checkbox"/>
Householder	<input type="checkbox"/>
Living with Parents	<input type="checkbox"/>
Lodging Address	<input type="checkbox"/>

RB49

# NEW! TAYLORMETER Model 127A

## 20,000 o.p.v. POCKET SIZE!

*Performance equal to a high priced instrument*

### OUTSTANDING FEATURES:

- ★ Sensitivity 20,000 o.p.v. D.C. 1,000 o.p.v. A.C.
- ★ 20 Ranges.
- ★ D.C. Current  $50\mu\text{A}$ , to 1 Amp.
- ★ D.C. Volts 0.3 v. to 1,000 v. (25 kV by probe).
- ★ A.C. Volts 10 v. to 1,000 v.
- ★ 3 Resistance Ranges from 0-20 megohms (self-contained).
- ★ Meter  $40\mu\text{A}$   $3\frac{1}{2}''$  arc.
- ★ Accuracy D.C. 3%, A.C. 4%.
- ★ Dimensions  $5\frac{1}{2}'' \times 3\frac{3}{4}'' \times 1\frac{1}{2}''$ .

**Price: £10.0.0**

### Credit Sale Terms available.

9 monthly instalments of  
£1.4.4.

Write for full details.

Complete with Instruction Manual and interchangeable test prods and clips. High quality leather case, if required, £2.18.0.

H.V. Probe for 25 kV ... £4.0.9



**TAYLOR ELECTRICAL INSTRUMENTS LIMITED**  
MONTROSE AVENUE,  
SLOUGH, BUCKS.

Telephone: Slough 21381

Cables: Taylins, Slough

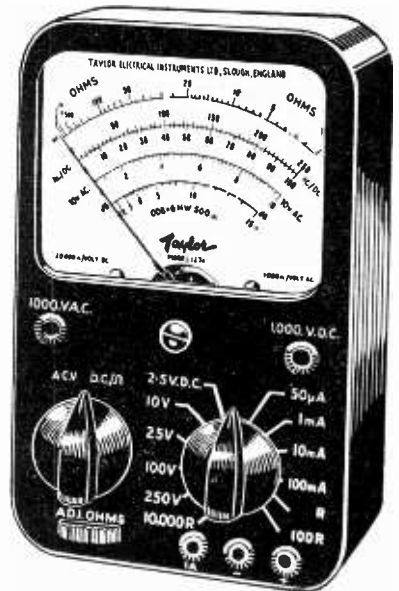

**TRUE**  
**ECONOMY**  
**Depends**  
**on Quality**

Midland "New Alumina" rebuilt C.R.T.s conform to the highest standard of reliability—offering you the finest value available today. Each tube is completely rescreened, aluminised and fitted with a new gun unit.

Midland's reputation for quality and the rapidly growing demand for these dependable tubes are your assurance of satisfaction.

12 and 14in.—£5. 15 and 17in.—£5.10.0. 21in.—£8.0.0 (all types).

Reliable Rebuilds at Popular Prices.

Exceptionally low-priced Midland Rebuilds—the tubes you can always depend on.

12in.—£4.10.0. 14in.—£4.15.0. 15 and 17in.—£5.0.0. 21in.—£7.0.0 (all types).

ALL TYPES COVERED BY MIDLAND'S 12 MONTH GUARANTEE AVAILABLE NOW—FROM STOCK

**MIDLAND TUBES LTD.**

37 GEORGE STREET, MANCHESTER, 1. Telephone: CENTRAL 4568/9



# IS IT THE TUBE?

By K. G. Jones

**B**ECAUSE the picture tube is still about the most expensive single component of a television set, one may be excused for feeling somewhat apprehensive over its health in the event of a black-out of vision. It should, therefore, be of some encouragement to the viewer whose set suddenly exhibits this symptom to know that there are a host of fault possibilities elsewhere in the receiver than in the tube which would be likely to cause exactly the same symptom. Indeed, the majority of tube faults give rise to symptoms other than a total black-out of vision, some of which will be examined in this article.

## Blank Screen

With this symptom, turning up the brightness control does not bring any illumination whatever, and yet the sound is working normally. On certain sets, an open-circuit tube heater is probable. This can be proved quickly by removing the rear cover and observing whether or not the heater is alight. If it is not, then there is trouble either in the heater or in the heater circuit. With A.C./D.C. receivers, the tube heater is in series with the valve heaters, and failure of the tube heater would usually result in all the other valves going out, so there would be no sound either. Thus, in the case of such a receiver, an unlit tube heater would invariably indicate a heater short. This sometimes happens, and the rest of the heater circuit is bypassed by the short-circuit. In most cases, however, a partial short occurs and the heater only reduces in brightness. This causes a different symptom which will be investigated in due course.

With A.C.-only receivers, the tube heater is possibly fed from a heater winding on a mains transformer, and in this case the heater could go open-circuit without affecting the heaters of the valves. Thus, if the tube is out in an A.C./D.C. set a heater short—or heater wiring short—should be suspected, and in an A.C.-only set an open-circuit tube heater—or open-circuit tube heater winding—should be suspected.

## Ohmmeter Check

The heater can be easily checked for continuity by an ohmmeter or similar device, but if this is not available a quick check on an A.C.-only set can be made by quickly short-circuiting the heater pins on the tube base with a screwdriver blade. If a small spark occurs, then voltage is present across the heater, and the heater itself is obviously open-circuit, unless, of course, there happens to be a poorly soldered connection between the lead-out wires from the tube neck and the heater pins. This possibility should be checked by applying a well tinned soldering iron to the heater pins, before the tube is finally abandoned.

There is no such simple check for a short-circuit heater, but in the rare event of the symptoms pointing to a total heater short, attention should be directed to the heater wiring to make sure that there is no short between the two-wires connected to the heater tags on

the tube base. If all is well here, then there is little doubt that the tube is responsible.

## Check EHT

The most likely cause of a blank screen is lack of EHT voltage on the tube final anode. This can be checked without instruments by first switching the set off, shorting the tube final anode to chassis with a screwdriver blade to discharge any possible EHT charge, removing the EHT connector from the tube and then, after switching the set on again, holding the EHT connector about  $\frac{1}{4}$  in. away from the chassis of the set, taking care to do this by holding the EHT cable insulation at least  $1\frac{1}{2}$  in. away from the metal connector to avoid shock and possible EHT discharge to the hand. If a vigorous spark occurs between the connector and chassis, it is safe to assume that some sort of EHT potential is present.

The spark should be yellowish in make-up, and since the discharge voltage should be D.C., a distinct crackle should result from the discharge. If the spark is essentially blue and is more of a flowing arc, it may be caused by neat pulse voltage as the result of a heater/anode short in the EHT rectifier. This fault, of course, would also prevent screen illumination, but the apparent presence of EHT at the tube often deceives even an experienced television technician.

## Check First Anode Voltage

Assuming lit heater and EHT, the next check with a tetrode or pentode tube should be to establish the presence of first anode voltage. This is not an easy check, since this anode is usually fed via a very high

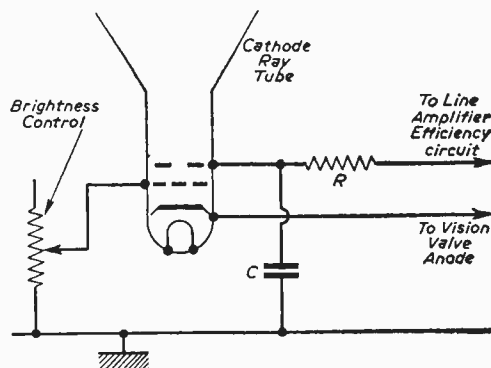

Fig. 1.—If the first anode potential is in doubt and a high resistance testmeter is not available, it would pay to check C and R by substitution.

impedance circuit from rectified pulse voltage somewhere in the line amplifier stage. The voltage (300-400) is insufficient to cause a detectable spark, unlike the EHT, and a high resistance moving coil meter or electro-static meter is generally called for to obtain an accurate measurement. However, if such an instrument is not to hand, it is not unduly difficult to check the anode-feed circuit components by substitution. There are usually only two or three components employed here, as shown in Fig. 1.

## Tube Bias

The tube could be cut-off due to a bias fault in the set. For example, a fault may occur which would

make the tube grid much more negative than the cathode, irrespective of the setting of the brightness control. In this event screen illumination would not occur, even with the brightness control turned full on. This can be proved by momentarily shorting the grid tag to the cathode tag on the tube base while watching the screen. If the tube screen lights up brightly when the short is applied, the trouble is almost certainly in the set, and not in the tube.

### Ion Trap Magnet

There is always the possibility that the ion trap magnet has shifted on the tube neck and as a consequence the electron beam has been deflected from the aperture in the ion trap assembly in the tube. This trouble should be suspected if the magnet is loose on the tube neck. On some magnets, the securing strap tends to break after a year or so use. This allows the magnet to drift from its correct position, even though the broken strap sections appear to be well fixed to the tube neck.

If the magnet is tightly secured, and the presence of dust on the tube neck makes it obvious that the magnet has not shifted, then it should not be re-adjusted just on a trial-and-error basis in an attempt to restore the lost picture. However, if the magnet is loose, it should be adjusted in the following manner.

Rotate the magnet until the arrow on it is immediately over the line marked on the neck of the tube. This line is normally approximately in line with the position corresponding to pin 3 on the base (Mullard tubes). Move the magnet along the neck until it is only slightly in advance of the tube base. It should

magnet to remove a shadow if, by so doing, the picture brightness is reduced.

There is always a possibility that the ion trap magnet may be faulty, but this is unlikely to be the case unless the magnet has been badly knocked or subjected to the field of another strong magnet. If the ion trap field is below normal, correct adjustment of the magnet will not give a fully bright picture, and some defocusing may be in evidence. A new magnet should be tried under these circumstances.

### EHT Short in Tube

If there is an internal final anode short in the tube or if the tube vacuum is impaired, the EHT may collapse to zero on connecting the EHT connector to the final anode pip. Similar trouble is likely if the EHT rectifier valve is low in emission. A very dim picture, somewhat larger in size than normal, may appear at a low setting on the brightness control, but as the control is advanced the picture will expand and disappear, leaving a blank screen and no EHT. It should also be noted that if a heater/anode short (or leak) exists in the EHT rectifier, the pulse potential on the heater will collapse when applied to the tube final anode (see under "Check EHT").

If all the foregoing checks give positive results, and illumination still cannot be obtained, then there is little doubt that the tube is in need of replacement.

### Partial Heater Short

When this happens in a tube with a series-connected heater (i.e., A.C./D.C.-type sets), the tube emission becomes impaired to a degree depending on how much of the heater is shorted. The picture will dim, and may go negative when the brightness control is turned up in an endeavour to secure a brighter picture. This trouble usually tends to be intermittent; the set working correctly after first switching on, and the picture gradually dimming after the set has been on a while. The fault may suddenly clear for no apparent reason, and the picture will return to normal.

If a shorting heater is responsible, the heater itself will be seen to dim when the symptoms occur, and become normal again when the short clears. The trouble can often be induced by gently tapping the neck of the tube with the handle of a screwdriver.

There are two ways in which the tube can be continued in service. One is to rotate the tube through 180deg. and refit it to the chassis. If this is unsuccessful, a separate heater transformer can be used for the tube. When the short occurs the transformer will hold the voltage constant, and an increase in current will occur in the operative section of the heater. This is not generally sufficient to fuse the heater, and in most cases clears the short.

### Low Emission

This is when the picture can be viewed only in a darkened room and an attempt to increase the brightness, by turning up the brightness and contrast controls, results in the picture becoming "flat" and of poor contrast. As with a partially shorting heater, the picture may turn negative or the white parts may take on a glistening, silvery appearance.

The focus may also be impaired, which would indicate that the tube is "soft" (poor vacuum) as well as low emission. These two faults often go hand-in-hand.

If the tube suffers only from low emission, and the picture focus is good, running a 6.3V heater at about

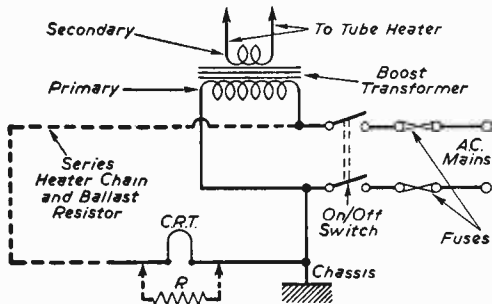
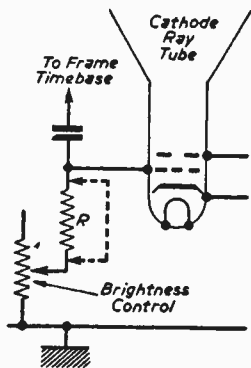

Fig. 2.—Connecting a boost transformer to an A.C./D.C. receiver. Resistance R is used as a substitute for the tube heater and serves to balance the heater chain.

be noted that in some sets that magnet may be fitted with the arrow diametrically opposite the line on the neck. In such cases the arrow must point towards the base of the tube.

After receiver warm-up, adjust brightness to three-quarters on and the contrast to a normal operating position, and if necessary move magnet until the raster or picture is only just visible. Without altering the brightness control, and keeping the arrow over the line on the tube neck, move the magnet gradually towards the screen until the raster or picture is at maximum brightness. Adjust the brightness control to give normal brightness on the peak white parts of the picture, and readjust the magnet to obtain maximum brightness. After the best results have been obtained, clamp the magnet into position if it is the type with the thumbscrew clamp. Never readjust the





**Fig. 3.**—If grid current prevents the brightness control from reducing the illumination sufficiently to give a picture of correct contrast ratio, normal operation of the control is restored by shorting resistor R (see text).

ary, giving the boost voltage, should then be connected across the vacated tube base tags.

Resistor R should have a value to suit the heater it is to replace, and can be calculated thus:  $R = E/I$ , where E is the tube heater voltage and I the current. With a 6.3V, 0.3A tube, R should be 21Ω, and 42Ω with a 12.6V, 0.3A tube heater. The nearest value obtainable should be used. The wattage rating for R can be calculated thus:  $W = I^2R$ . A 3W type should be used with a 6.3V heater and a 5W type with a 12.6V heater, giving a degree of tolerance.

**Heater-to-Cathode Short**

This invariably gives uncontrollable brightness. Sometimes only a raster exists on the screen, while at other times a poor picture shaded heavily at top or bottom may be present, depending on the design of the receiver's video amplifier stage. When the fault occurs in A.C./D.C. sets, the cathode of the tube is taken, via the short, virtually to chassis potential,

8V or a 12.6V heater at about 15V invariably restores emission for a period, and allows the tube to continue in service. A boost transformer is required for this purpose, of which there are many various types on the market at the present time. A transformer can only be used on A.C. supplies, of course, and the arrangement adopted in A.C./D.C. receivers is shown in Fig. 2. The primary of the boost transformer should be connected across the receiver side of the set's on/off switch, and the primary should suit the local mains voltage. The existing two wires to the heater tags on the tube base should be removed and connected across a resistor R. The second-

possibly across 50c/s. This almost, or completely cuts off the picture signal to the tube-cathode and also short-circuits the standing voltage from the video amplifier. The grid thus becomes far more positive than the cathode, over the whole range of the brightness control, and the screen illumination cannot be reduced.

In an A.C.-only set in which the tube heater is energised from a winding on the mains transformer which is isolated (such as certain Ultra models), a heater/cathode short in the tube would not cause uncontrollable brightness, but would result in very poor definition due to the capacitance of the transformer windings appearing in parallel with the picture signal at the tube cathode. It often happens that the heater/cathode short is of an intermittent nature, and then the poor definition occurs spasmodically. The effect is rather like the picture suddenly going out of focus, although the horizontal scanning lines are maintained, and sometimes horizontal bands of the picture tend to pull out of line towards the left of the screen.

One solution to the problem, apart from replacing the tube, lies in using a low-loss isolating transformer to operate the tube heater. This may, or may not give a boost voltage, depending on whether or not the tube also needs a boost in emission. With A.C./D.C. sets, the transformer should be fitted as shown in Fig. 2, but with A.C.-only sets the transformer should be used in place of the existing tube heater winding on the mains transformer. Its low-loss characteristic avoids the higher video frequency components from being bypassed by the high capacitive losses of the original transformer.

**Grid Current**

Tubes in which the vacuum is failing often give the effect of grid current owing to ionization of the gas. This may happen before any serious deterioration in focus is observed, and in some sets slight grid current has no ill effect. In other sets in which the grid circuit is loaded by a high impedance circuit to introduce flyback line suppression, the grid current may make it impossible to reduce the picture brightness sufficiently to give the correct contrast ratio. In this case, the high impedance can be bypassed, and although this results in the elimination of the flyback line suppression circuit, at least the brightness control is restored to normal operation (see Fig. 3).

**FRAME TROUBLES EXPLAINED**

*(Continued from page 561)*

In the same models, a bright horizontal line at the middle and bottom of an otherwise blank screen is an almost certain indication that the 20D1 vision detector has a heater/cathode short.

**Poor Interlace**

Modern receivers have excellent interlace performance, and any serious shortcoming can almost certainly be attributed to a fault somewhere in the set. On sets with a blocking oscillator, the blocking oscillator transformer developing some slight winding fault can easily cause this trouble. Frame timebase valves are another cause, although they check normal on a valve tester. The only way of really being sure is by substitution. Poor smoothing should also be

suspected, and attention should be directed to the screens and shields associated with the line output stage and EHT circuits. During the line flyback there is a severe disturbance in the line circuits generally, and if the screening is ineffective line pulses may be reflected into the frame oscillator and give slightly irregular frame oscillator triggering, and consequent line pairing.

**Frame Bounce or Judder**

Again, this could be caused by a defective frame blocking oscillator transformer or faulty frame valve. In the days of the gas-filled oscillator valves (T41's, 6K25's, etc.) much trouble of this nature was experienced as such valves aged. When this symptom is persistent, and appears to occur at critical settings of the height and vertical hold controls, consideration should be given to the frame circuit decoupling components, as well as to the valves.

# A Dual-purpose Converter Unit

A USEFUL INSTRUMENT FOR CONVERTING BAND I CHANNELS TO BAND III

By L. E. Higgs

**W**HAT use is a converter that raises a Band I channel up to Band III? We are all used to the familiar conversion of Band III to Band I, there are thousands of those all over the country. But this, what can it do, and what does it cost?

This unit is modified from an existing ITA converter costing about 30s. 0d. second hand from a dealer, a couple of odd bits from the scrap box, and a little time. It performs the following functions:

- (a) provides strong Band III signal for work on TV in districts where the signal is weak.
- (b) extends the range of "Band I only" pattern and signal generators up to Band III.
- (c) supplies sound and picture simultaneously, accurately spaced.
- (d) covers all Band III channels with a turn of the dial.
- (e) as a miniature transmitter, it can test peak tuning and matching of aerials, duplexers, installations, and TV front ends.

The block diagrams in Fig. 2 show the few basic changes to the wiring. Any similar converter could be so adapted, but the present instructions apply to the Plessey type, chosen for the ease of tuning, good screening, and the convenient flat shape that can stand over, under, or at the side of the existing equipment.

The instructions are divided into sections. By following them in the correct order, and making the

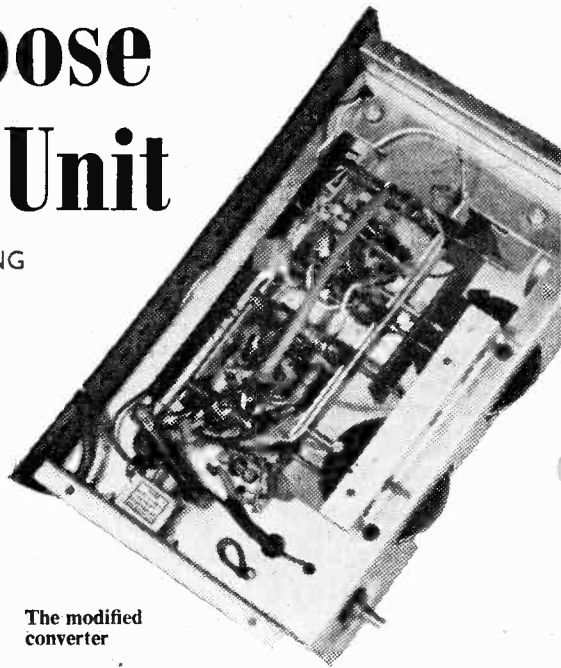

The modified converter

stage to stage tests, risks of errors are reduced, and mistakes quickly found.

### Circuitry

Originally the converter was a Band III cascode R.F. amplifier (PCC84), feeding the frequency changer (PCF80). The old Band I output was taken from the anode circuit, and the local triode oscillator working below the signal frequency, produced Band I by frequency subtraction. Frequency addition is the way Band III is produced after modification—with interestingly enough, no alteration to the local

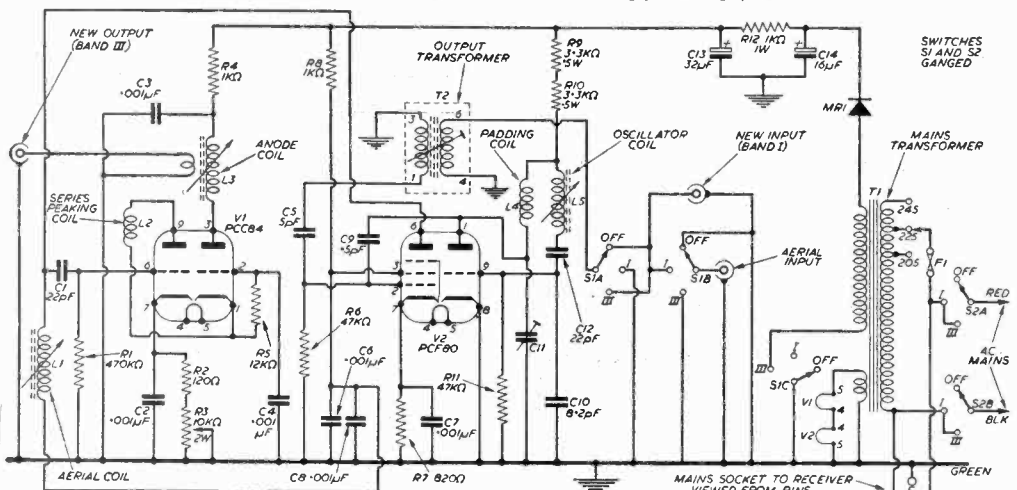

Fig. 1.—Circuit diagram of the modified converter. (A capacitor of 47pF is wired from pin 6 of V2 to chassis.)

oscillator frequency. The PCF80 now becomes the first valve in the circuit, and feeds its output into the cascode circuit which amplifies it and becomes the output stage.

All details given here are designed to make the converter function with the least disruption to existing wiring layout, the least amount of work, and no special equipment for realigning. No coils or fixed components have to be moved, only the wiring is altered. Better efficiency would be possible if the coils, valves and general layout were repositioned. But the upsetting of the precision tracking, and factory adjusted component values, all well balanced, would not be worthwhile, as it is the results are good, despite theoretical losses, and my own converter works well, providing strong BBC on channel 8 from an indoor aerial.

These converters were manufactured by Plessey and are found bearing the names of many different well known firms.

**Stage 1**

Test the converter on a TV receiver first, working normally. Make sure that the gain is good, tuning reasonably accurate, and that valves, H.T. rectifier, and smoothing are in order. While it is running, probe the wiring, valves in their bases, and switch contacts for intermittent connections, especially the coaxial input sockets. Correct any defects. Test and disconnect mains.

**Stage 2**

Remove the cover, four bottom screws and the two pull-off knobs. Lay the chassis upside down on the bench with the knobs facing you. Keep to this position

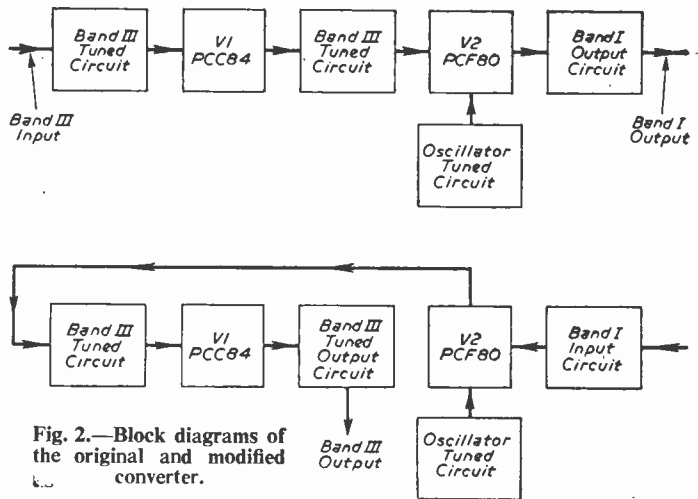

Fig. 2.—Block diagrams of the original and modified converter.

as all future references to layout assume this view. V1 (PCC84) is on the R.H. side, and V2 (PCF80) is on the L.H. side. Mark the chassis V1 and V2 next to the bases to avoid errors.

Cut off the link between pin 6 of V2 and the canned output transformer. Cut away C5 (5pF) from pin 3 of V1, close to the tag leaving L3 connection intact. Leave the pin 2 end of C5 alone, and bend the capacitor round from under the oscillator coil, over pin 8 V2 without touching anything. Extend the free end of C5, slip over a short piece of sleeving, and solder on to the vacant tag left on the output transformer from the first operation. Keep this C5 connection short and pulled tight.

Remove the H.T. junction pair R8 (1k) and the red wire to pin 3 of V2, from the output transformer. Leave these two wires connected, but suspended above the transformer. Earth the tag vacated by them. Leave alone any small tuning capacitor found across these two tags on the output transformer as they were fitted on some models.

Carefully unsolder the thick bare wire (from pin 3 of V1 to L3) at the L3 end and fold away from L3 1/2 in. This will be reconnected later.

Connect a short, thick, sleeved wire from the empty pin 6 of V2 to the end of L3 disconnected in the last operation. Make a coupling winding of 2 turns of p.v.c. insulated wire soldered to earth and the coaxial inner (see Fig. 3) unsoldered from L1 and pulled across as close to L3 as possible. Insulate the join to prevent shorting to chassis.

**Stage 3**

Clip off the few inches of coaxial cable connected across the aerial output socket—this was a tuned rejector circuit but will attenuate the input signal.

This is the end of the first half

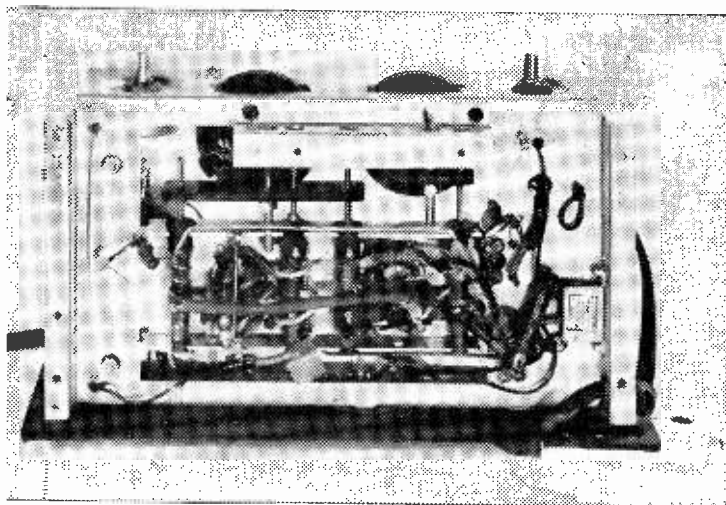

Underchassis view.

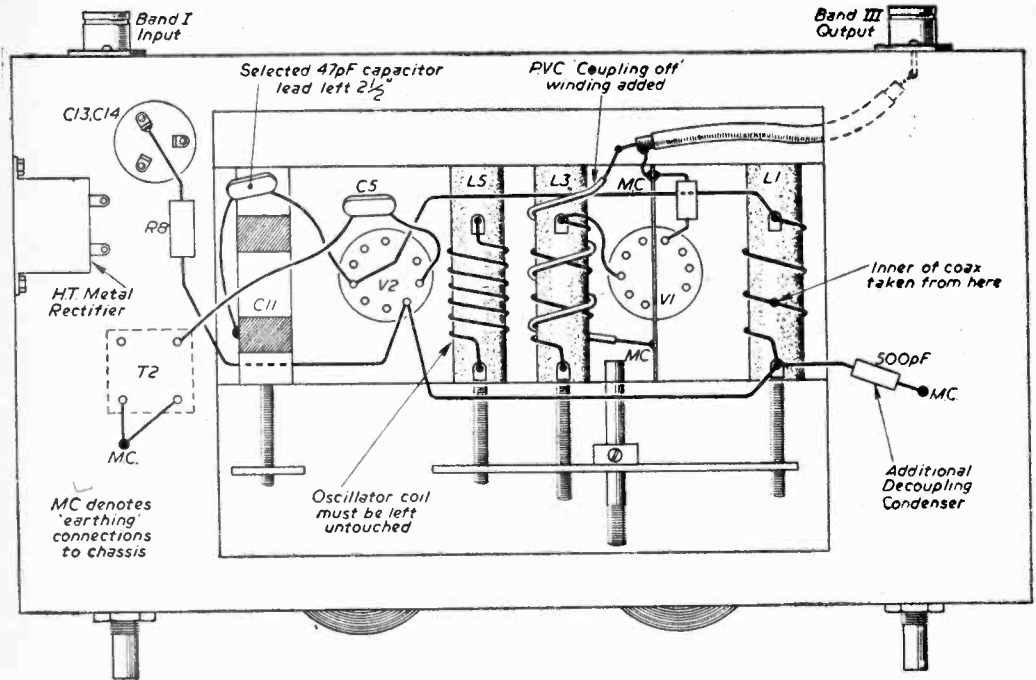

Fig. 3.—Underchassis view showing the changes in wiring.

of the modification. We can now test V2 without any amplification from V1, and if we can produce a weak Band III output, continue with the last part.

Connect the converter to the mains, switch the converter to Band III (fully clockwise) and check H.T., V2 pins 1, 3 and 6 for H.T. and see if V2 is alight.

Switch on a sensitive TV receiver. Select the local Band III channel. Fully increase the contrast and sensitivity controls and switch to "distance" where applicable.

Connect the TV receiver to the converter new Band III output, the former Band III input via a short length of coaxial.

Into the new input Band I socket (former aerial output) feed the strongest Band I signal you can obtain—full output from a signal generator is best. Then, rotate the channel dial through its complete travel until some signal is received.

Once an output is detected and identified as the input is converted to Band III, no matter how weak, retain it by leaving the oscillator alone. Tune up L3 and T2 individually with an insulated trimmer to a maximum. Do not worry about bandwidth, that can be seen to when there is signal to spare. The received output should be near the indicated channel on the dial of the converter if the converter oscillator has been left undisturbed. This cannot be over emphasised. The most that can be expected when all have been peaked at this stage is a grainy, barely locked picture, quite satisfactory, provided the sound is coming in with the vision. Should however the sound and vision be received reversed—sound only, or vision only, the sound channel being on the "wrong side" of the picture—then the oscillator is running too high in frequency, probably due to some alteration to

the circuit constants. (See the symptom table on page 580 for possible errors and their correction.)

#### Stage 4

This part is the connection of the V1 cascode circuit to amplify the low output from V2. Switch off the converter from the previous test. Disconnect and lay the chassis on the bench as before. Completely remove the link between pin 6 of V2 and L3, recently fitted in stage 2. Unsolder carefully the L1 end of resistor R1. Bend it up to the thin metal screen crossing the base of V1 and solder it to the coaxial earth connection there. (Leave the pin 6 end of R1 untouched.) Solder a thick tinned copper wire from pin 6 of V2 (16 s.w.g. sleeved) and connect it to the tag on L1 from which R1 has just been removed. Again keep this lead as short as possible—pulled tight across L4, L3 and V1 without any pressure on the components en route causing "shorts". Reconnect pin 3 of V1 to L3 (removed earlier). Cut off the earth to chassis from the untouched end of L1 and replace this link with an additional R.F. recoupling capacitor of 500 pF ceramic type. Keep the ends short (see Fig. 3). Connect this same end of L1 with a length of p.v.c. wire to the pin 3 V2 and route it as shown in Fig. 3.

Lastly and most important, connect an additional capacitor from pin 6 of V2 and the earthy end of C11, as shown in Fig. 3. This capacitor should be 47pF ceramic, high K, and soldered in as shown without cutting down the end leads. They should be  $2\frac{1}{2}$ in. long. In some way, this size condenser on leads of

(Continued on page 580)

# STEREOSCOPIC TELEVISION

By C. Pickward

**I**N an ever-increasing number of instances, television is being called upon, not only for the remote observation but also for the remote control and manipulation of materials and processes. Unfortunately, however, one of the important senses lacking in the normal television picture is the appearance of depth, and this will inevitably lead to difficulties and inaccuracies in judging distance when using television for remote handling and control. There is therefore a growing requirement to have the third dimension in industrial television pictures and it is to meet this requirement that Pye now add to the standard range of equipment the Beam Splitting Attachment ref: 842085 and the 14in. Mirror Stereoscope ref: 842086.

## Principles

Since it is because we have two eyes (each seeing things from slightly different aspects), that we are able to see scenes three-dimensionally, it follows that any three-dimensional television system must also have two "eyes", or putting it more correctly there must be two physically displaced points-of-view. To fulfil this binocular requirement it has been the usual practice in the past to duplicate almost all the equipment normally found in a normal television chain, together with attendant complexity of operation and servicing and increase in space and cost.

The latest additions to the standard equipment catalogue seek to provide the answer to true stereoscopic television, whilst adding none of the difficulties previously mentioned. In order to appreciate how the two units mentioned above are able to synthesise sense of depth in the mind of the observer, it is necessary to digress slightly into the theory of stereoscopic vision, on which a short discussion follows:—

## Stereoscopic Vision

The normal practice is to use both eyes when observing one's surroundings but since the two eyes see the scene from slightly different viewpoints the observer is really seeing two different pictures at the same time. The optical axes of the two eyes also converge to some extent to meet in the objects on which attention is concentrated at any instant. Mental processes then fuse the two differing pictures into one which has the appearance of solid relief. This effect of relief and depth is the "stereoscopic effect".

It is lost in the normal television chain since the camera sees things from one angle only. Whilst it is true that skilful lighting and the placing of shadows can do something towards creating an illusion of depth, it cannot do everything.

To re-create the full sense of depth it is necessary to obtain two views at the same time with a camera having a means of obtaining those views from slightly displaced viewpoints, so that it copies the actions of the two eyes. If it is then arranged that each of these views is only capable of being seen with one eye, then (if certain other conditions are also met), the resultant picture will be stereoscopic.

## Separate Cameras

There are many ways in which the above effect

may be obtained and the most obvious way would appear to be the use of two separate cameras which have their optical axes separated by approximately the distance between the human eyes; namely, 2½in.

In the system being discussed the stereoscopic effect is obtained by a mirror beam splitting system at the camera position and a system of mirrors at the monitor position which have the effect of providing each eye with the relevant picture information.

## Advantages

With the system as described certain advantages exist over the more conventional methods. These advantages may be summarised as follows:—

(1) The system may be readily added to an existing installation and conversely it may be removed from a stereo-installation to give normal monocular pictures.

(2) Consisting as it does of simple mirrors, there is nothing to wear out or need servicing.

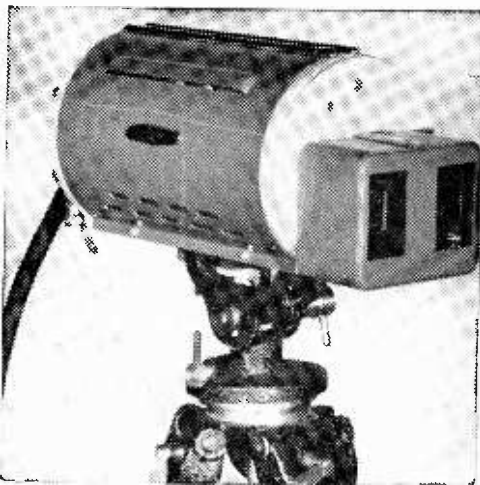

A Pye Stereoscopic Camera.

(3) Electrically and electronically the camera equipment is standard and if necessary the pictures may be transmitted using standard equipment.

(4) It is possible to make viewing attachments to suit all standard monitor sizes and if a particular requirement exists for audience viewing, this can be arranged by changes in the display system, although it will then be necessary for the observers to wear polaroid spectacles.

(5) The angle of view with the standard system is equivalent to using a 1in. focal length lens (28deg. horizontal angle) although the depth of field is equivalent to a ½in. lens. This is an important feature of the system as it is known that the eye cannot tolerate out-of-focus information in a 3D picture and this requirement can be met with lower high-levels than those required in more conventional stereoscopic systems.

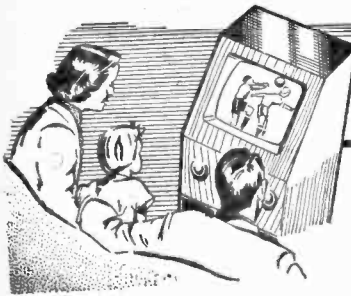

## UNDERNEATH THE DIPOLE

TELEVISION PICK-UPS AND REFLECTIONS

By Iconos

"WHY can't we see the Royal Variety Performance?" is a question that has been annually asked by viewers for years. At last their wishes have been granted, and, thanks to the wonders of videotape recording and the negotiations of Val Parnell and the directors of ATV, they had an opportunity of seeing it on the ITA network. Almost every viewer in the land able to switch over to commercial television did so, and TAM research estimated that no less than 22,300,000 viewers in 8,064,000 homes saw it. This beat the previous record of 7,183,000 homes which were said to have tuned in to "Wagon Train" on 8th February, 1960. And what of the show? Lacking that special electric sense of historic occasion felt by the live audience in the theatre itself and produced for television under the greatest possible technical improvisation, it proved to be a near-disaster. The fact was, that the picture quality of the transmission was exceedingly poor—and the performance of many of the acts was very much below normal. In fact, the programme content left much to be desired. What was the reason?

### What Television Can't Do

EVERYBODY in variety, cabaret, rock and roll, pantomime and concert party wants to be in the Royal Variety Performance. The result is a procession of good artistes (and a few not so good) who are necessarily not allowed sufficient time to put over their acts and make that "contact" with the audience which is so essential for a good variety show. Some first-class performers had mere walk-on parts, and those who had the privilege of speaking were mainly given lines which weren't worth delivering. In the case of the "accent on youth" scene, it was quite impossible to hear any words sung by Adam Faith, Cliff Richards

and Lonnie Donegan—though I admit this is not the first occasion this phenomenon has occurred. Diana Dors, a good sketch artiste, appeared in a very bad sketch, and Jimmy Edwards merely walked across the stage in search of his trousers. Charlie Drake did a moderately funny balloon routine, which was probably much funnier when one saw the multicolours of the balloons in the actual theatre, but failed to register on television. The Crazy Gang looked pathetically ancient. The most successful act in the show, in my opinion, was Liberace, who was given far more time than anyone else and who played popular classics with showy precision, great bravura and gaiety. In his case, one heard quite clearly his chummy little

verbal introductions, though his act would have been even more effective without dialogue interpolations.

Technically, the ATV producer had to make-do with poor camera positions, coloured stage lighting and scrappy rehearsals. On top of this, the tape recording of the picture was very much below the standard we have come to expect. It looked more like a poor tape recording of an American show transferred to film for British use. But the main fault of the show was probably the packing in of too many artistes. This always seems to happen, ever since the first Royal Variety Show at the London Palace Theatre in 1912. Then, there were twenty-two acts, including George Robey, Vesta Tilley,

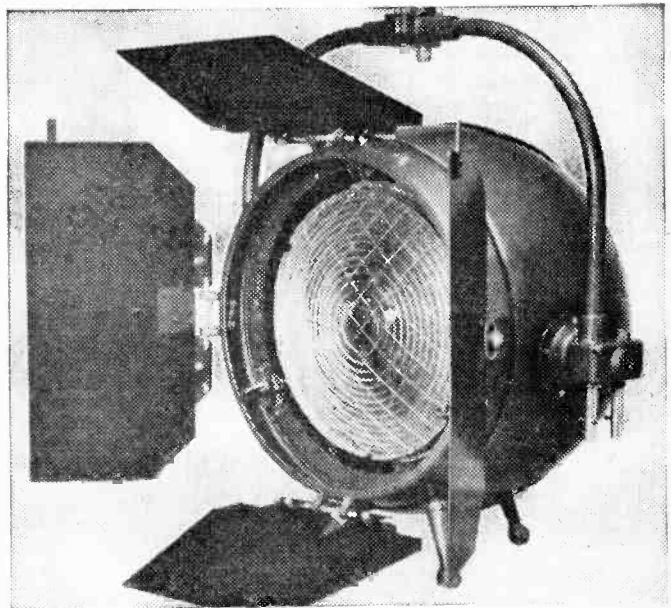

An all purpose flood or spot-light, especially designed for Television.

(The Mole-Richardson Duo-Light)

Chirgwin, Anna Pavlova, David Devant, Sir Harry Lauder and other stars which have now become legends. I have several very old Edison phonograph cylinders of Sir Harry Lauder, whose diction and personality still come over splendidly in tuneful song on the old trumpet machine, far better than the youthful accents in present-day Royal Variety.

Nevertheless, when Royal Variety comes around next year, we'll all want to see it and the TAM rating will probably be higher still. "Why can't we see the Royal Performance?" will again be heard. Next time, with better camera positions and technical facilities, let us hope we see it in a manner worthy of the occasion

#### **BBC's All Star Show**

**W**ITHIN a few days of the Royal Performance, the BBC put on a special all-star charity show presented by the Lords Taverners entitled "Up Green and At 'em". This was a piece specially written for television in period melodrama style, very well produced, with first class technical results. Again, many top stars had mere walk-on parts—but this didn't seem to matter. A good time was had by all, in the manner of an end-of-term frolic. This cricketing melodrama came over very well indeed, and a Lords Taverners' television presentation may well be another annual event. The Lords Taverners is a show business society which helps charities and "watches cricket", and I look forward with some curiosity as to how they will work the great game into their next year's all-star show: will it be drama, cabaret, revue or film?

#### **Competition**

**T**HE competition between the three main British manufacturers of television studio and transmitter equipment is intense and it is interesting to watch the speedy introduction of new designs, their prototypes and the rapid appearance of production models which are sold all over the world. Pye, Marconi and E.M.I. are certainly on their toes and now seem to lead the world in the ingenuity of their designs and the reliability of their apparatus. Each week, one or other of them announces some new triumph, a new piece of apparatus or a new equipment contract. The latest trend is for television engineers to "shop" for their equipment, selecting TV camera

channels from one firm, telecine from another and other odd pieces of equipment from individual specialist firms. Nevertheless, there is usually one firm which undertakes the major part of the equipment and is quite ready to include additional items provided by their rivals. Thus, Ulster has its main studio equipment by Marconi, telecine from Pye and the ITA transmitter is also Pye. Associated Rediffusion's new studio at Wembley uses the newly designed E.M.I. 4½in. image orthicon cameras in conjunction with other equipment from Marconi and Cintel. ABC Television's Teddington Studios will do likewise. Westward Television at Plymouth will have the new Marconi Mark IV cameras, master control, special effects generators and other Marconi equipment working alongside E.M.I. and Cintel telecine machines and the new revolutionary Pye caption scanner. In lighting, too, there are competitive British firms, G.E.C., Strand Electric and Mole Richardson (England). British lighting equipment, with its flexible mountings and dimmer control, also leads the world in this field. Progress is so swift that it makes the film studio equipment which was first adapted for television purposes seem archaic. Indeed, new film studios being built on the Continent are being fitted out, not in the traditional film manner, but with British television-type lighting grids and lanterns.

#### **Japanese Electronics**

**J**APAN has entered television in a big way, just as it has in the camera, photographic and optical field. Hitherto, the Japanese have contented themselves with making copies of British, American and German equipment, the craftsmanship of which reached a very high standard. Now they are progressing with some original ideas of their own. The Japanese equivalent of the BBC, which is called "N.H.K." has developed two or three startling new devices. Perhaps the most exciting is a very small and light image orthicon camera which weighs only 37lb and is almost entirely transistorised. This is designed for mobile outside broadcast use. It is part of a complete unit, comprising camera, control unit, microwave transmitter, aerial and batteries—the whole outfit weighing only 170lb. Much weight is saved with transistors, on which the Japanese have made great progress. The Japanese also have their own videotape recorder. This has a single recording head only, which records the whole picture of one field on a diagonal track across the magnetic tape. It is, of course, non-compatible with Ampex and R.C.A. videotape machines and can only be run on a play-off machine of its own type. Nevertheless, if it is available at a low price, it may well be used by European television stations.

## **PRACTICAL WIRELESS**

### **Chief Contents of August Issue**

#### **Now on Sale 1/6**

GRID DIP OSCILLATOR  
SIMPLE TUNING METER  
15W QUALITY AMPLIFIER  
PRECISION PICK-UP ARM  
ELECTRONIC COMPARISON OHMMETER  
THE DISTRIBUTED LOAD PHASE REVERSER  
INEXPENSIVE P.A. EQUIPMENT  
BATTERY SUPERHET TUNER  
AN AUDIO OSCILLATOR  
THE SIMPLIAMP  
ETC., ETC., ETC.

# Letters to the Editor

The Editor does not necessarily agree with the opinions expressed by his correspondents.

**SPECIAL NOTE:** Will readers please note that we are unable to supply Service Sheets or Circuits of ex-Government apparatus, or of proprietary makes of commercial receivers. We regret that we are also unable to publish letters from readers seeking a source of supply of such apparatus.

## 625 LINE DEFINITION

**SIR,**—The recent letters on the modification of a British receiver for the reception of 625 line pictures are no doubt topical, and I should like to give details of my experiments carried out some time ago. I was at the time using an Argus receiver which has an electrostatic timebase. In this, it was merely necessary to change the capacity of the condensers in the timebases. This effectively modified the sweep rate, but when I later tried this out on an electromagnetic set I was able to change the frame section, but on the line-timebase I found that the change of speed resulted in a reduction in EHT. I could not obtain the full voltage by any means, and eventually dispensed with fly-back EHT, using an R.F. EHT unit. Unfortunately, other things intervened and I stopped my experiments, but if it is finally decided to introduce this higher definition in this country obviously I shall have to start again. I definitely think that 625 lines will eventually be used.—R. MANSELL (Rickmansworth).

## A UNIT SET?

**SIR,**—As there must be many experimenters like myself who would like to try out various ideas, I think it would be a good idea to publish a design for a TV set in unit form. That is, the tuner as one unit, the separate timebases as individual units, etc. By this means it would be possible to give from time to time ideas for new circuits which could be easily changed, and then inserted into the receiver so that their efficiency, etc., could be gauged. Is there any reason why this has not been done? Perhaps one of your more experienced readers has worked out something on these lines and could let us have the results of his experience and experiments.—H. R. OLIVER (Penge).

## MAINS SMOOTHING

**SIR,**—I recently converted my commercial set to a "home constructor-experimenter's" model, so that I can carry out modifications, and one of the first things I noticed when dismantling the power pack was the fact that the mains transformer had no smoothing in it. Most American circuits seem to favour the connection of one or two condensers across the primary or secondary, an earth being provided on the condenser or to the junction of the two where two are used. I had always experienced jittery pictures with the set, and it was mainly this which finally led me to try to make an experimental set of it, as I had been unable to

find a cure. I fitted two 0.01 $\mu$ F (750VW) condensers from each side of the transformer H.T. secondary to earth and the picture is now steady and I wonder that this idea is not more commonly employed in British apparatus.—G. R. DE NEULL (Hastings).

## SLOT AERIAL RESULTS

**SIR,**—I was interested to see the article in the March issue on slot aeriels, and I tried out the Fig. 4 arrangements for London. It was very disappointing, so I started to experiment with the arrangement. I found that the number of anchoring wires attached to the braiding of the cable and the bottom of the slot was fairly critical in my case, and in place of a single wire wound round and round for the entire half length of the slot I use three single loops of wire soldered all the way round so there was no wire left unsoldered. At the other end I supported the bare inner lead originally on sticks of wood, but eventually used four lengths of ebonite, with a brass screw driven into the centre, the head cut off and the lead soldered on top of it. This ensures that the wire lies in the same plane as the actual edges of the slot—not about half an inch out of the plane of the slot. The results now are much better than my proprietary dipole with reflector and the complete screen is anchored to the main rafters in the loft with ordinary bell wire staples. It was a very well worthwhile improvement.—G. R. WATTS (N.W.).

## COMMON TV FAULTS

(Continued from page 563)

By the use of a directional aerial, as shown in Fig. 2(b), the direct signal causes the major response since it is in direct line with the aerial, and is encompassed by the major axis of the directional pattern of the aerial, as shown. The response to the reflected signal is considerably less because it arrives at an angle of relatively low signal pickup. Thus, it will be appreciated that by carefully orientating such an aerial optimum discrimination between the direct and reflected signals is possible.

Fig. 2(c) shows that even multiple reflections can be adequately suppressed in some instances by the use of a critically positioned directional aerial. Such an aerial may be required even if the direct signal is very strong, its purpose then being solely that of discriminating between the wanted and unwanted signals.

In very hilly districts the direct signal may be greatly attenuated by a hill, in which case it may be possible to align the aerial to one of the reflected signals. The picture quality often suffers when this is necessary, but it at least permits reasonable viewing which would not otherwise be possible.



# Trade News

## NEW PRODUCTS AND DEVELOPMENTS

### Polystyrene Cabinet for Pye TV

**B**ECAUSE of the use of polystyrene, a new slim 17in. television set, recently introduced by Pye Ltd., is available in four different colours. This set, Pye Model V.220, has 100deg picture tube for wide angle viewing. A forward facing loudspeaker makes possible "side-by-side" vision and sound.

The cabinet is moulded in Styron 475 polystyrene, by The TV Manufacturing Co. Ltd., Lowestoft, a member of the Pye Group. This material has enabled Pye to offer colour variety in the following shades: pastel green, pastel grey, tangerine and wood graining, all with contrasting picture surrounds. The V.220 slim 17in. TV is available from all Pye dealers and retails at 57 guineas.

### Multipoint and Television Relay Systems

**A**N installation/planning service for multipoint and television relay systems is operated by Aerialite Ltd., free of charge and without obligation, from their Aerial and Electronic Division, Hargreaves Works, Congleton. This service is available to Borough Planning Officers, Contractors, Architects and the Trade in general. Enquiries, together with plans if available, should be forwarded to the Relay Engineering Department, who will then submit a material quotation and full wiring diagram. Should a site test be required to ascertain signal strength the Aerialite Mobile Research Unit is available at a moderate fee.

A new catalogue is now in circulation, dealing with multipoint and television relay systems. It is fully illustrated with information on installation

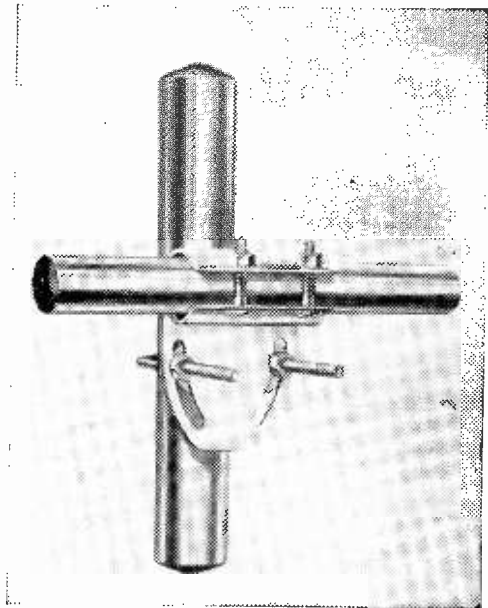

The "Antiference" three-way aerial clamp.

methods, Aeraxial television relay cables and accessories used. A copy of this catalogue and further information may be obtained from *Aerialite Ltd., Castle Works, Stalybridge, Cheshire.*

### Three-Way Clamp

**T**HE "Antiference" No. 10 three-way clamp fits masts up to 2in. diameter. It is particularly robust and provides a wide range of adjustment in all directions—tilting, rolling or turning for anti-ghosting or oblique and the falling wave fronts. Designed with the horizontal aerial in mind, it permits any array to be mounted directly on to an angled mast. Alternative slots are provided in the boom clamping plate for  $\frac{3}{4}$ in. or 1in. diameter booms. Priced at 6s. 6d. this new clamp may be obtained from *Antiference Ltd., Aylesbury, Bucks.*

### Dynatron Vanguard

**T**HE latest addition to the range of Dynatron television receivers is the Vanguard. This Console receiver is a 21in. "press-key" model. By pressing the appropriate key BBC and ITA television programmes, Home, Light and Third VHF/FM broadcasts are

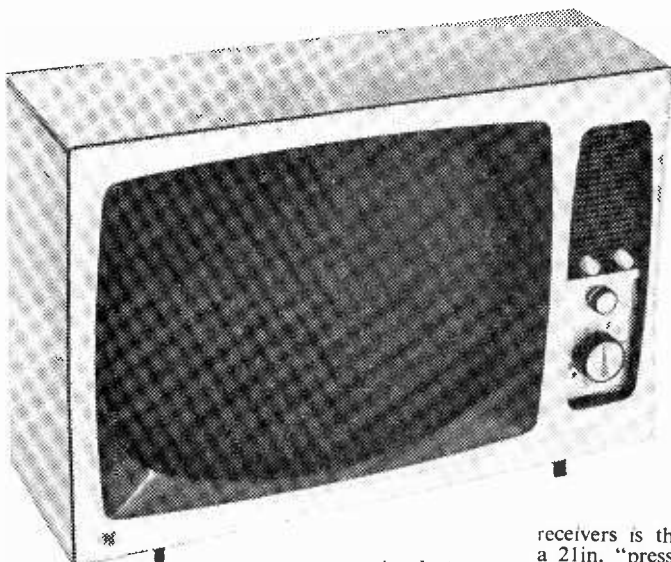

A polystyrene cabinet is used for this new Pye receiver (model V.220)

selected immediately by means of a noiseless synchronous motor, geared to a high efficiency turret tuner. Eight selector keys are provided on the receiver front panel and four controls, brightness, contrast, volume and tone. All pre-set controls are located at the rear of the receiver. The Vanguard is available with a choice of two cabinets in Queen Anne or Chippendale style with full length doors. Both cabinets are finished in walnut veneer. Two models are available TV50 and TV50CH. The retail prices are 185 guineas and 170 guineas respectively. The Vanguard is made by Dynatron Radio Ltd., Maidenhead, Berks.

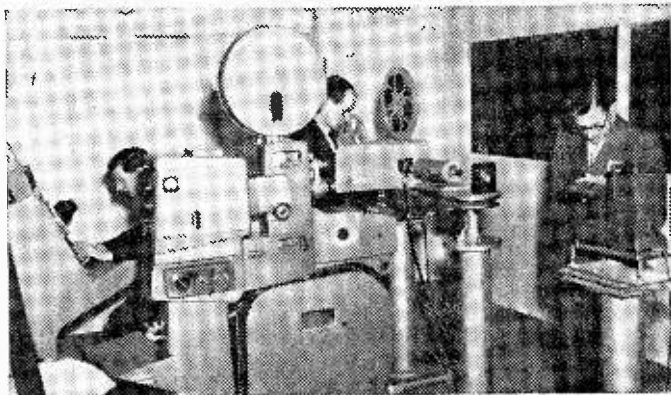

Marconi Telecine equipment type BD 884

### Vidicon Telecine Equipment

PRIMARILY intended for closed-circuit use, and based on the Vidicon Camera Channel, the Marconi Vidicon Telecine Equipment Type BD 884 is an ideal system for the previewing of television advertising films and is also well suited to a variety of other closed-circuit applications involving the transmission of film or slides. The special feature of this equipment is the facility for rapid alignment of the camera to

receive pictures from any one of up to four sources. A field lens in front of the camera, on to which the appropriate projected image is focused, eliminates the need for readjustment of the camera optical system when re-alignment is made. Any desired combination of 35mm, 16mm or slide projectors may be used. Further information on this equipment may be obtained from *Marconi's Wireless Telegraph Company Ltd.*, Marconi House, Chelmsford, Essex.

## A DUAL PURPOSE CONVERTER UNIT

(Continued from page 574)

this length acts as a resonant circuit and greatly aids the long unconventional connection from V2 anode and L1. This long lead also forms a part of the V2 anode circuit with trimming of L1 being the means of tuning. It will pay the experimenter to try different values for this capacitor after the converter is finished, aiming at maximum output on the Band III channel most used. The coupling coil also pays for a little systematic trial and error with extra gain. All the information here is given as the best results obtained with a particular converter under certain local conditions. Most likely the individual will find that variations in values and layout will improve the final result—after the converter is working.

### Stage 5

With the converter outside its case, connect up as before and switch on. There should be a considerable signal now at about the same channel position as before. Systematically tune L1, L3 and T2 for a maximum. See that the TV used as a monitor is not masking the effects of your adjustments with AGC. This is likely now with a strong signal, and you may have to attenuate between the converter and TV. Moving the 47 pF capacitor around that part of the chassis also affects the gain.

Refit the converter into the case observing any variation in output. The tuned circuits may be reset by trial and error until the output is a maximum when the case is refitted.

### SYMPTOM TABLE

- |  |   |
|--|---|
| <p>(a) Good results but stations not in line with dial setting.<br/>Adjust L5.</p> <p>(b) No output but a bright burst of light on screen with a pop or humming sound as the converter is tuned through a point.<br/>Oscillator running at Band III output frequency. Check L5 and oscillator wiring.</p> <p>(c) Bright light and humming sound—unaltered by converter tuning.<br/>Instability in V1 or between V1 and V2. Check decoupling and for straggly wiring alterations.</p> <p>(d) Low output.<br/>Check tuning, missing valve voltages, faulty coax lead, and test extra components used.</p> <p>(e) When tuning L1, L3 and T2, if they will not</p> | <p>tune through a peak then add a little capacity or electrically shorten the coil to make up for wiring variations.<br/>Patterning.<br/>May be due to the local Band III signal breaking in on the new output. Try using the adjacent Band III channel—if the TV is equipped with the turret coils. Check the screening of the converter. Try earthing it.</p> <p>(f) Poor bandwidth.<br/>On Test Card C progressively detune T2 and L3 until sufficient resolution compatible with gain is obtained.</p> <p>(g) Insufficient sound.<br/>Adjust T2 but expect a reduction in picture strength. Make sure that the channel selector is in tune with the receiver before starting.</p> |
|--|---|

TUBES

DIRECT FROM OUR FACTORY New low prices. New top quality guns. ALL GUARANTEED

Table listing vacuum tubes categorized by 6 months, 12 months, and 12 months new types. Includes models like CRM92, MW22-7, 12EPA, etc. with prices in pounds and shillings.

NEW 108K (10in.) TUBES SPECIAL OFFER: 29/- PLEASE NOTE: Many other types not listed available. S.A.E. enquiries.

13 CHANNEL TV's

TABLE MODELS, FAMOUS MAKES. Complete with all valves and tubes. These sets are unequalled in value due to huge purchase direct from works. They are untested but are not guaranteed to be in working order.

- AMAZINGLY POPULAR-IDEAL SECOND SETS 12" - £3.19. 14" - £6.19. 17" - £9.19. 12" 5 CHANNEL TV'S 45/-. 14" 5 CHANNEL TV'S 85/-.

ALL DRY PORTABLES

Stella Lightweight Shoulder-strap model, upper finish, economy valves, listed at £13.25, medium and long waves, absolutely complete in manufacturer's sealed cartons. £7.19.

4-SPEED RECORD PLAYERS

Latest B.S.R. TU9. Turntable together with lightweight Star Gear dual sapphire crystal turnover pick-up head. £3.10.

100 CONDENSERS 10/-

Assortment of miniature silver mica and ceramic condensers. 3-10,000 pF. List value over £5.

100 RESISTORS assortment 7/6

5-2 watt.

PM SPEAKERS 3 ohms, top makes, performance guaranteed.

8in. 8/- 5in. 11/- 10in. 13/-

CO-AX standard and low loss, 25 yds., 12/6.

50 yds., 22/6, 100 yds., 42/6. Co-ax. Plus 1/3. Wall outboard boxes. 3/6.

SMASH HITS

B.S.R. UA8 Monarch with famous Xtal Stereo Cartridge. Unrepeatable. £6.19

STEREO OUTFITS

Consisting of Stereo B.S.R. UA8, together with two separate 3 tube mains amplifiers, 3 valves (10P2, 10P14, U09) with 8 in. Speakers in two tone cases with controls. Also screened leads. NOTHING ELSE TO BUY! £11.10!

3 WATT AMPLIFIERS as above, ideal for P.A. Guitars, Grams, etc. Ex. quality. 49/-

Latest SAGATONE Recorder using Collaro Transcription 3-epd. Deck, Superimpose 5 Valves, Ex. Reproduction, 3-Tone Case. Worth £46. Amazing Value. 29 Gns.

VALVES SOILED, GUARANTEED 3 MTHS. EY51, PL81 AMAZING VALUE 4/6

12in. TV's 5 channel table models including speaker, line trans. cabinet. Top makes requiring only valves and tube to complete your choice if available. 15/- (carr. 4/-). Or £5 per dozen, carr. free.

14in. TV's 5 channel as above 35/- (carr. 4/-).

RECTIFIERS 12 volt 3 1/2 amps. 9/6.

R.M1. 6/6; R.M2. 8/-; R.M3. 9/-; R.M4. 15/6; R.M5. 21/-; 14A86. 17/-; 14A97. 23/-; 14A100. 26/-; 16R1-1-16-1. 7/9; 18R1-1-16-1. 7/9; 18R2-2-8-1. 14/-; 14R1-2-8-2. 17/-; 14R1-2-8-3. 20/-.

TURRET TUNERS

38 Mc. I.F. Standard Famous Make with coils listed. £7. Complete with PCF80 and PC84 valves, boxed (carr. 3/-).

External I.T.V. CONVERTERS WITH INTERNAL POWER PACK. Finished in hammered gold. Very compact. Trimming controls. Gain and Trimming controls. Listed at 27.7.0. Our Price, carr. 2/6. £9 10 0

B.S.R. MONARDECK TAPE DECKS £9 10 0 COLLARO TRANSCRIPTION DECKS £18 15 0

VALVES BY RETURN OF POST

10% DISCOUNT SPECIAL OFFER to any SIX VALVES marked in black type (15% in dozens). Post 1 valve, 6d. 2-11, 1/-.

NEW LOW PRICES GUARANTEED 3 MONTHS

FREE TRANSIT INSURANCE. All valves are new or fully guaranteed ex-Government or ex-equipment origin. Satisfaction or Money Back Guarantee on goods if returned unused within 14 days.

Large table listing various vacuum tube types (e.g., 6X4, 6AR5, 6BQ6, 6BE6, 6BD6, 6BE7, 6BE8, 6BE9, 6BN8, 6C4, 6CA6, 6CD6, 6CG6, 6CH7, 6CH8, 6CH9, 6CL6, 6CL7, 6CL8, 6CL9, 6D2, 6D3, 6D4, 6D5, 6D6, 6D7, 6D8, 6D9, 6E4, 6E5, 6E6, 6E7, 6E8, 6E9, 6F4, 6F5, 6F6, 6F7, 6F8, 6F9, 6G4, 6G5, 6G6, 6G7, 6G8, 6G9, 6H6, 6H7, 6H8, 6H9, 6I6, 6I7, 6I8, 6I9, 6J6, 6J7, 6J8, 6J9, 6K4, 6K5, 6K6, 6K7, 6K8, 6K9, 6L6, 6L7, 6L8, 6L9, 6M2, 6M3, 6M4, 6M5, 6M6, 6M7, 6M8, 6M9, 6N6, 6N7, 6N8, 6N9, 6P6, 6P7, 6P8, 6P9, 6Q6, 6Q7, 6Q8, 6Q9, 6R6, 6R7, 6R8, 6R9, 6S6, 6S7, 6S8, 6S9, 6T6, 6T7, 6T8, 6T9, 6V6, 6V7, 6V8, 6V9, 6W6, 6W7, 6W8, 6W9, 6X4, 6X5, 6X6, 6X7, 6X8, 6X9, 6Y6, 6Y7, 6Y8, 6Y9, 6Z6, 6Z7, 6Z8, 6Z9) and their prices.

Post: 2 lbs. 1/6, 4 lbs. 2/-, 7 lbs. 2/9, 15 lbs. 3/6 etc. No C.O.D. ALL ITEMS LESS 5% + POST FREE IN DOZENS. (Callers always welcome). LIST OF 1000 SONS 6d. P.O. BOX 21 (W) 350-152 FRATTON ROAD, PORTSMOUTH.

TECHNICAL TRADING CO.

**"Better get the best—  
it costs less"**

# VIDIO



Offers you the finest rebuilding service available today! Each tube is completely rescreened, aluminised and fitted with a new Gun Unit! Available now — for IMMEDIATE DELIVERY!

12"—£5. 14"—15"—17"—  
£5. 10. 21"—£8.

**VIDIO'S SECOND CHOICE  
—GUN UNITS.**

12"—£4. 10. 14"—£4. 15.  
15"—17" £5. 21"—£7.

**ALL TUBES GUARAN-  
TEED FOR ONE YEAR.**

Get full details now from

## VIDIO REPLACEMENTS LTD.

Hales St., Deptford High St.  
London S.E.8. Tel: TID 4506

## A QUALITY TAPE RECORDER for



only Deposit and 12  
mthly. pymts. of 30/-  
80/- Carriage and Packing 8/6

**CASH 19 gns. *The Carol***

Fitted with the brilliant new B.S.R. tape deck and including 850ft. of Tape, Spare Spool, Acos Crystal Microphone. The Carol recorder is really sensational value for money. Fully guaranteed, incorporates features usually found only in much more expensive units: Simplicity of operation ★ Special automatic device to prevent erasure ★ Over 1 1/2 hours playing time ★ Large room output (2 1/2 watts) ★ Full tone range ★ Fast forward and rewind speeds. Attractive red and grey case with vilt fittings.

## ELECTROVAC

**NEW GUN CATHODE RAY TUBES**  
Unbeatable prices 12 months' guarantee

Brand new guns

12"	MULLARD, MAZDA, FERRANTI, EMITRON	£4.4.0
14"	CATHODEON, G.E.C., COSSOR TYPES	£5.5.0
17"	" " " " " "	£6.6.0
21"	MULLARD, MAZDA, FERRANTI, COSSOR AND EMITRON TYPES	£9.9.0

Plus carriage, packing and insurance 10/-, refundable in full on receipt of old tube in our carton supplied  
Cash with order. Regret no C.O.D.

**TELEVISION ASSURANCE (Dept. PT.16),  
47 WATFORD WAY, HENDON, N.W.4.**

# NEW! DO-IT-YOURSELF TRAINING TECHNIQUE in RADIO & ELECTRONICS

**You LEARN while you BUILD...**

**SIMPLE...PRACTICAL...FASCINATING...** 1st stage receiver

ANNOUNCING—after many years of highly successful operation in the U.S.A. and in Europe—the latest system in home training in electronics is now introduced by an entirely new British training organisation. **AT LAST**—a comprehensive and simple way of learning—by practical means—the basic principles of radio and electronics, with a minimum of theory. **YOU LEARN BY BUILDING** actual equipment with the components and parts which we send you. You advance by simple steps using high quality equipment and performing a whole series of interesting and instructive experiments. **No mathematics! INSTRUCTION MANUALS** and our teaching staff employ the latest techniques for showing clearly how radio works in a practical and interesting manner. **IN FACT** for the "Do-it-Yourself" enthusiast, the hobbyist, or those wanting help with their radio career training, or to set up their own full or part-time servicing business—then this new and exciting instructional system is exactly what is needed and it can all be provided at very moderate cost. Easy payments available. Post the coupon now, for full details. There is no obligation.

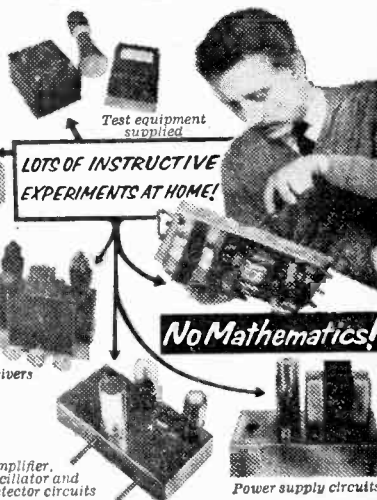

**LOTS OF INSTRUCTIVE  
EXPERIMENTS AT HOME!**

**No Mathematics!**

**BUILD YOUR OWN • RADIO EQUIPMENT • TEST GEAR  
• HI-FI INSTALLATION—AND LEARN AS YOU DO IT**

# RADIOSTRUCTOR

BRITAIN'S LEADING RADIO TRAINING ORGANISATION

**FREE-  
POST TODAY**

To: RADIOSTRUCTOR (Dept. C40),  
40 Russell Street, Reading, Berks.

Please send brochure, without obligation, to:

Name \_\_\_\_\_  
Address \_\_\_\_\_

**BLOCK  
CAPS.  
PLEASE**

(821) We do not employ representatives 9-80



Whilst we are always pleased to assist readers with their technical difficulties, we regret that we are unable to supply diagrams or provide instructions for modifying surplus equipment. We cannot supply alternative details for construction articles which appear in these pages. WE CANNOT UNDERTAKE TO ANSWER QUERIES OVER THE TELEPHONE. The coupon on p. 587 must be attached to all queries, and if a postal reply is required a stamped and addressed envelope must be enclosed.

#### KB KV35

The fault is with the picture. It keeps going "foggy" but after a while changes back to clear again.—C. Crabtree (Bradford 4).

We would suggest you replace the R19 EHT rectifier (on the front of the left side line output transformer) and check the 50CD6 and 12AU7 valves.

#### PAM 954

The frame collapsed leaving a narrow band of light across the screen. When switched off and left for a short time the picture came back clear, but now there is no picture and the screen will not light up. I renewed valves PY81, PL81, and checked the others. There is current on H.T. and the tube heater lights up. The line whistle can be heard.—A. Graham (Renfrew).

The initial collapse of height should have directed your attention to the frame time base ECL80 valve and its associated components. The present complete loss of picture means that you will have to check first the EHT (EY51 lighting?) by draining a spark from the EHT cap of the tube. If this is absent, check again at the anode of the EY51. If a spark is here suspect the EY51 but check the tube by removing the anode clip and noting the effect. Check the setting of the ion trap magnet on the rear of the tube neck and the voltage supplies to the base socket.

#### PHILIPS 11150

The fault is a blank screen (no EHT). The line timebase is in order as the whistle is present. Also a fair spark of about 1/16in. can be had at the anode connection of the EY51. This valve refuses to light up. I have changed the EY51 also the PL81 and I have checked the heater winding for

the EY51 which is OK. I was viewing when the breakdown occurred and the picture collapsed into the centre, rapidly, while still retaining the general shape. About half an hour before the breakdown occurred there seemed to be intermittent mains interference.—W. Barker (Portsmouth).

The line output transformer would appear to be at fault but you should check the 3.9k resistor to pin 8 of the PL81 and the 0.056 $\mu$ F (56,000pF) capacitor near the large 100 $\mu$ F under the front of the timebase chassis. Check PY81.

#### RAYMOND F100

When the set is switched on the sound comes on first but as the picture appears the sound goes off then comes back after about two minutes. As the sound comes back it is accompanied by a loud buzzing. This buzz can be stopped by switching the set off and on rapidly, but it returns in a very short time. Usually a bass note of music or any low sound will bring it back. This buzz does not alter with moving the volume control or the turret tuner. Also there is a lack of brightness on the tube, with both brightness control and contrast set right up there is no raster at all. The picture width control affects the ion trap magnet. Is it possible to fit an extra booster transformer on the tube?—P. Howley (Bradford 7).

The poor sound may be due to a defective ECL80 audio-output valve. This is situated on the right side of the chassis behind (or more correctly, in front of) the line output section. The tube may be boosted by wiring a 5k 10W resistor from the mains dropper or voltage panel (J or K) to pin 1 of the CRT base.

#### PLESSEY CHASSIS 984/T10

On switching on, the screen showed a raster but no sign of modulation. The sound is fine and all the heaters are glowing. The night before I had had a good picture before switching off. I have tried interchanging the valves (6F1's) and EB91's. The video amplifier valve grids become red hot. I have tried the tube for cathode/heater short with 100V and a 1.2mA meter and cannot get a reading between the two. The brightness seems to be working normally. I assume the tube to be OK. There is also a slight fault in the line linearity and line hold controls. I cannot get a good raster unless both of these are right up. I have converted one of these I.F. strips to take a 34.38Mc/s tuner which I intend to fit.—T. Hyde (Radlett).

The video amplifier is caused to overheat by oscillation in the I.F. stage. This is normally due to feedback caused by an open-circuited decoupling capacitor associated with pin 4 of the 6F1. Also check EL38 and associated resistors and capacitors.

#### H.M.V. 2807

The dropping resistor behind the voltage selection panel has burnt out. What is the resistance of each of the four sections?—P. Mann (Bristol).

The 2807 dropping resistor has four sections R58 at the bottom then R59, R60 with R61 at the top.

R58 has a value of  $69\Omega$ , R59  $54\Omega$ , R60  $51\Omega$  and R61  $16\Omega$ .

### BUSH TV 43

This set is about five years old. I have been boosting the tube with a  $5000\Omega$  5W resistor as shown in PRACTICAL TELEVISION. This improved the picture. After the set has been switched on for about five minutes the screen glows very bright with no control of brightness. A light tap on the cabinet brings the picture back which stays until the set is switched off. I have a CRT transformer with 20 per cent boost and I would appreciate your advice on how to connect it. The tube is an MW36-24. Sometimes the objects on the screen have slightly ragged edges on their right-hand side.—A. Chapman (Rawdon).

The tube apparently has an intermittent heater/cathode short. An isolating transformer should be fitted to overcome the effect of this. The primary should be wired with one lead to chassis, the other to the junction of the two fuses. Remove the boost resistor and dispense with this. Remove the heater leads to pins 1 and 12 and short these leads together. Connect the transformer secondary to pins 1 and 12.

### K.B. KV50

I wish to fit a new tube in my 17in. television receiver. In addition to the usual symptoms of an ageing tube there is insufficient line output leaving about an inch gap down either side. Could this be due to anything other than a weak line output valve 6CD6G? I have not yet tested this valve.—F. Wakefield (Co. Durham).

Remove the front control knobs, the rear cover and the side chassis fixing screws. Remove the speaker leads from the rear right side output transformer. Slide out chassis complete with tube. Remove the tube base socket, ion trap magnet and EHT connection from the side of the tube. Release front clamping band and ease tube through focus magnet, slackening scanning coils and removing rubber band on neck by degrees. Reverse procedure when fitting a new tube (Brimar C17FM). The setting of the ion trap magnet is critical. Check the 6CD6 valve.

### EKCOVISION 207

The U801 has burnt out fairly frequently, and on the last occasion the U801 and the on/off switch burnt out together. I replaced the U801 and in order to test the set I bridged over the switch. The screen lit up but there were diagonal lines from top left corner of the screen. This was with no aerial connected. Before connecting the aerial into the set I observed that the U801 was burning rather brightly and the 20P1 burned with a purple glow. After altering the tapping on the mains transformer, which made no difference, I switched off the set and when again I switched on, the U801 had burnt out. In the last two instances the filament of the valve has become separated from pin two and is shorted to pin one. I can find no visible cause for an increased voltage reaching the heater chain in which the U801 is situated.—F. Smythe (Glyn Neath, Glam).

Your fault may be due to heater/cathode leakage

on the 20P1, which is over-running the U801. This type of leakage occurs only when the set is warmed up, making cold tests difficult. Alternatively, some of the four  $100\Omega$  surge limiters on the U801 may be burned out, making the valve work in an unbalanced condition. A further possibility is a short to chassis of the heater winding on the mains transformer.

### MURPHY V240

I wish to replace the EHT rectifier which I think is a Mazda U25 in the above set. Will you please tell me where this valve is positioned in the set and instruct me as to the procedure for removing and replacing same?

The U25 EHT rectifier is mounted inside the oil-filled line output transformer, and to replace it involves discarding the complete transformer and replacing it by a new one. Several readers have tried repairing these units but have difficulty in making an airtight seal; in fact, the makers have even discontinued their reconditioning service.

### BUSH TV24

This set has no EHT. I find on taking scan-coils plug out, the EY51 lights up and EHT comes to life, but is very weak. On testing top cap of line output valve there is a very good spark.

Could you also give me the resistances of the scan-coils as I have no service sheet for this set?—J. Raffel (Co. Durham).

The scan-coils of the TV24 rarely give trouble, but if they are breaking down a meter is not likely to reveal the defect unless they are o.c. at one point. The total resistance of the scan coils is  $30\Omega$ .

Check  $2\mu\text{F}$  capacitor under centre of main deck on the long tag strip, also PZ30 valve.

### PYE TV4

After it has been switched on for about two hours the picture gradually gets dimmer and dimmer until it is barely visible. Altering all the various controls outside the set makes no difference, and when the set is switched off instead of clearing the screen instantly as it always has done, it slows up to a small ohlong very bright, and takes two or three seconds to disappear from the screen.—S. Williams (S.E.15).

The symptoms your set displays are those of a faulty C.R. tube. Before changing or boosting it check that the ion trap magnet is set to give the brightest possible picture.

### PHILIPS PROJECTION TG600A:15

Half an hour or more after switching on, the picture becomes distorted, shimmering and finally moves over to the left, leaving a black line on the right, fairly clear, but occasionally flickering and giving a double image. Adjustment of the horizontal hold fails to correct fault. Also the picture frames sometimes roll over and over downwards, and only very fine adjustment to the vertical hold control will correct this. I live in a fringe area.—J. Merrett (Saltdean, Sussex).

You should check the UL44 line output oscillator valve by replacement, also the electrolytic

# FIRST IN QUALITY - FOREMOST IN ECONOMY



Suffolk's reputation for reliability accounts for the rapidly increasing popularity of Suffolk rebuilt tubes. Now you can obtain "NEW ALUMINA" C.R. Tubes of all types completely rescreened and alumimised—at an exceptionally low price!

Sensational value with the existing range of picture tubes!

Suffolk's FULL 12 MONTH GUARANTEE is your assurance of satisfaction. You get FREE DELIVERY anywhere in the U.K. when you trade with Suffolk, the largest independent tube rebuilders in London.

**SUFFOLK TUBES LTD**

**SUFFOLK HALL, 1-3 UPPER RICHMOND ROAD, PUTNEY, S.W.15**

Telephone: VAN 5267, 4304



## R.S.C. BRADFORD, LEEDS (Leeds) Ltd. and MANCHESTER

Post Terms C.W.O. or C.O.D. No C.O.D. under £1. Postage 1/9 extra under 2£. 2/9 under 2£. Open to callers 9 a.m. to 6 p.m. Wednesdays until 1 p.m. S.A.E. with enquiries, please. Trade supplied.

### R.S.C. TRANSFORMERS

Fully Guaranteed  
Interleaved and Impregnated  
Primaries 200-230-250 v 50 c/s screened  
**TOP SHROUDED DROP THROUGH**  
250-0-250 v 70 ma, 6.3 v 2 a, 5 v 2 a .. 17/9  
350-0-350 v 100 ma, 6.3 v 2 a, 5 v 2 a .. 18/9  
250-0-250 v 100 ma, 6.3 v 4 a, 5 v 3 a .. 23/9  
300-0-300 v 100 ma, 6.3 v 4 a, 5 v 3 a .. 23/9  
350-0-350 v 100 ma, 6.3 v 4 a, 5 v 3 a .. 23/9  
350-0-350 v 150 ma, 6.3 v 4 a, 5 v 3 a .. 23/9

**FULLY SHROUDED UPRIGHT**  
250-0-250 v 80 ma, 6.3 v 2 a, 5 v 2 a  
Midget type 21-3-3in. .... 17/11  
250-0-250 v 100 ma, 6.3 v 4 a, 5 v 3 a .. 25/9  
300-0-300 v 100 ma, 6.3 v 4 a, 5 v 3 a .. 27/9  
350-0-350 v 100 ma, 6.3 v 4 a, 5 v 3 a .. 27/9  
350-0-350 v 150 ma, 6.3 v 4 a, 5 v 3 a .. 35/9  
425-0-425 v 200 ma, 6.3 v 4 a, C.T.  
6.3 v 4 a, C.T. 5 v 3 a .. 49/9

**FILAMENT TRANSFORMERS**  
All with 200-250 v 50 c/s Primaries: 6.3 v.  
1.5 a, 5/8; 6.3 v. a, 7/8; 0-4-6.3 v 2 a, 7/8;  
12 v 1 a, 7/11; 6.3 v 3 a, 8/11; 6.3 v 6 a, 17/8.

**CHARGER TRANSFORMERS**  
200-250 v 0-9-15 v 1 a, 12/9; 0-9-15 v 3 a, 18/9;  
0-9-15 v 6 a, 18/9; 0-9-15 v 6 a, 23/9.

**OUTPUT TRANSFORMERS**  
Midret Battery Pentode 66:1 .. 3/9  
Standard Pentode 5,000 to 3 ohms .. 3/9  
Small Pentode 5,000 to 3 ohms .. 5/9  
Standard Pentode, 75,000 to 3 ohm .. 5/9  
Push-Pull EL84 to 3 or 15 ohms .. 18/9  
Push-Pull 10-12 watts 6V6 to 3 or 15  
ohms .. 18/9  
Push-Pull 10-12 watts 6V6 to 3, 5, 8 or  
15 ohms .. 19/9

**SMOOTHING CHOKES**  
100 ma 10 h 250 ohms .. 8/9  
80 ma 10 h 250 ohms .. 5/8  
80 ma 10 h 400 ohms .. 4/11

### SELENIUM METAL RECTIFIERS

Special quotes for quantities of 50 to 5,000  
H.T. (H.W.) F.W. (Bridge)  
250 v 50 ma .. 3/11 6/12 v 1 a .. 3/11  
250 v 80 ma .. 5/11 6/12 v 2 a .. 6/11  
250 v 100 ma .. 6/11 6/12 v 3 a .. 9/9  
Contact Cooled 6/12 v 4 a .. 12/3  
250 v 80 ma .. 6/11 6/12 v 5 a .. 14/6  
250 v 75 ma .. 6/11 6/12 v 6 a .. 15/6  
F.W. (Bridge) 8/11 6/12 v 10 a .. 25/9  
6/12 v 15 a .. 27/9

**CO-AXIAL CABLE** 1in. 75 ohms 14/36 .. 8d. yd.  
Twin-screened Feeder .. .. 11d. yd.

**BATTERY SET CONVERTER KIT**  
All parts for converting any normal type  
of Battery Receiver to A.C. mains 200-250v  
50 c/s. Supplies 120 v, 90 v or 60 v at 40 ma,  
fully smoothed and fully smoothed L.T.  
of 2 v at 0.4 to 1 a. Price including circuit,  
48/9. Or ready for use, 9/9 extra.

**ALL DRY RECEIVER BATTERY  
ELIMINATOR KIT**—All parts for the  
construction of a unit (metal-case  
5½-4½-2in.) to supply Battery Portable  
receivers requiring 90 v and 1.5 v. Fully  
smoothed. From 200-250 v 50 c/s mains.  
Price, in. point-to-point wiring dia-  
grams, 39/9. Or ready for use, 46/9.

**D.C. SUPPLY KIT**—Suitable for Electric  
Trains. Consists of mains trans.,  
200-250 v 50 c.p.s. A.C. 12 v 1 a Selenium  
F.W. Bridge Rectifier, Fuseholders, 2  
Fuses, Charge Direction Switch, Variable  
Speed Regulator. Partially  
drilled Steel Case, and Circuit. **33/9**

**AUTO STEP UP/STEP DOWN  
TRANSFORMERS**  
0-110-120-230/250 v, 50-80 watts 11/9,  
0-110-120-200-230-250 v, 150 watts, 27/9.

### TELEVISION RECTIFIERS

250 v 200 ma, Size 3 x 1½ins. Brand  
New. 8/9.

**EX-GOVT. MAINS TRANSFORMERS**  
All 200-250 v 50 c/s Input.  
Removed from New ex-Govt. units. **22/9**  
270-0-275 v 100 ma, 6.3 v 7 a, 5 v 3 a  
300-0-300 v 60 ma, 6.3 v 2 a .. 11/9  
265-0-265 v 150 ma, 6.3 v 11 a, 5 v 3 a, 5 v  
3 a .. 29/11  
350-0-350 v 100 ma, 6.3 v 2 a, 5 v, 2 a .. 18/9  
0-10-25 v 24 a, .. 79/6. cart. 15/-

**EX-GOVT. SMOOTHING CHOKES**—  
60 ma 5-10 h 250 ohms .. 2/11  
80 ma 10 h 150 ohms .. 6/9  
100 ma 5 h 100 ohms Tropicalised .. 3/11  
100 ma 8-10 h 100 ohms Parmeko .. 6/9  
120 ma 12 h 100 ohms .. 8/9  
150 ma 10 h 150 ohms .. 9/9  
200 ma 3-5 h 100 ohms Parmeko .. 7/9

**EX-GOVT. CASES**. Well ventilated,  
black crackle finished, undrilled cover.  
Size 14 x 10 x 8½in. high. IDEAL FOR  
BATTERY CHARGER OR INSTRUMENT  
CASE, OR COVER COULD BE USED FOR  
AMPLIFIER. Only 9/9, plus 2/9 postage.

**BATTERY CHARGERS**  
For 200/250 v 50 c/s A.C.  
mains. 12 months' guar-  
antee. Attractive, well  
ventilated hammer  
finished cases, 6v or 12 v,  
4 amp, with meter  
and variable charge  
rate selector, as illus-  
trated. **69/9**  
cart. 5/-  
Or Deposit 13/3 and 6  
monthly payments of  
13/3. 6 v or 12 v 1 amp  
type. Also suitable for  
electric train power supply. Only 29/9  
post 2/9.



# LOOK!!

## A Genuine Unrepeatable Offer

ABSOLUTELY BRAND NEW  
10", 12", 14", 15", and 17"

# CATHODE RAY TUBES

All made by England's leading manufacturers

Because of very special bulk purchases we are able to offer the home constructor and the amateur repair mechanic these absolutely brand new

### TV TUBES

at fabulously low prices. Carriage and Insurance paid.

10" **£3.3.0** 10"  
Cossor type 75K.

12" **£5.5.0** 12"

Direct replacement for MW31-16, MW31-74, CI2FM, I21K, I2XP4, I2XP4A, T12/100.

14" **£6.6.0** 14"

Direct replacement for MW36-22, MW36-24, MW36-44, C36-24, CI4HM, I4LP4, I4KP4A, TR14/22

15" **£4.4.0** 15"  
Cossor type 85K.

17" **£7.0.0** 17"

Direct replacement for MW43-64, I7ASP4, I7AXP4, TR17/21, I71K, I72K. We also can supply a tube at this price equivalent to CRM171 but with a 6.3 volt heater instead of 12.6 volt, and non-aluminised. Please specify.

17" **£7.7.0** 17"

Direct replacement for MW43-69, CI7HM, TR17/22. Also a tube directly equivalent to CRM172.

These tubes are not reconditioned, or "seconds", or export rejects but **BRAND NEW BOXED STOCK** direct from the factory and made available by special bulk purchases which are unrepeatable.

Unconditionally guaranteed for full twelve months from date of purchase if returned securely packed.

Take advantage of this special bargain now. Orders executed by return. Send cash, cheques, etc., with order to:

**ST. JAMES'S GENERAL TRADING AND INVESTMENT CO. LTD.**

2 SERJEANT'S INN, LONDON, E.C.4

Please note that we are MAIL ORDER only. We regret that we cannot cater to callers.

**TAKE THE PROBLEMS  
OUT OF SOLDERING**



**HENLEY  
SOLO**

TRADE MARK

**RELIABLE  
SPEEDY  
LONG-LASTING**

**FOR 25 YEARS THE BEST  
ELECTRIC SOLDERING IRON**

*Leaflets on request from:*



**AEI CABLE DIVISION**

**Associated Electrical  
Industries Ltd**

Distribution Equipment  
Sales Dept  
38-39 Upper Thames Street  
London, E.C.4.  
Telephone: CENtral 2332  
25 watt instrument  
model (illustrated)

# REGUNNED TV TUBES

Supplied from stock and despatched by British Railways, same day. **COMPLETE NEW MULLARD or SUPERIOR ELECTRON GUNS** fitted in every tube, and fully guaranteed for **12 MONTHS FROM DATE OF INSTALLATION.**

Mullard AW AND MW types available.

		<i>Mullard</i>	<i>Mazda</i>
12 in.	-	£5.0.0	£5.0.0
14 in.	-	£5.0.0	£5.0.0
15 in.	-	—	£6.0.0
17 in.	-	£6.0.0	£6.0.0
21 in.	-	£8.0.0	£8.0.0

Carriage & Insurance 10/- extra.

Other types available; Brimar, E.E., G.E.C. etc. C.W.O. to:—

**CLARKSONS** (Tube Distributors)

120 Commercial Road, LEEDS 5



capacitors in general and the  $65\mu\text{F}$  associated with the video amplifier in particular.

#### SOBELL 143

All the valves and the tube light but there is no sound or vision on this set. The valves have been tested and found to be in order. I removed the mixer valve and I.F. and put a Brayhead Turret Tuner in with an adaptor from another set of the same number and make. On adjusting the fine tuner coil I can receive sound but still no picture. I believe the trouble is in the mixer stage but it looks O.K. and there are no burnt resistors.—P. Gittons (Glamorgan).

Check V1, EF80 and V2, ECL80. Also check the voltages on both of these valves. It is most likely that, if the valves are in order, R10 is o.c. This is a  $220\text{k } \frac{1}{4}\text{W}$  resistor between pin 8 on V2 and H.T.

#### G.E.C. BT 5144

The picture is fairly satisfactory but there is a faint white band vertically across the left hand side of the screen. The band is about 1in. wide and its centre is about  $2\frac{1}{2}$ in. from the left hand margin. Fly-back lines are sometimes visible, with their left-hand ends meeting the right side of this white band.

Is it reasonably easy to fit a tetrode tube in place of the existing triode? If so, where can I obtain the necessary H.T. for the first anode?—J. Marchant (Putloe).

This trouble is due to poor functioning of booster diode U31, although the KT36 may also be suspect. A tetrode can be used, voltage for A1 being taken from the cathode of the booster diode. Vertical hold in the wrong position will cause these flyback lines.

#### STELLA ST 8621U

This set vibrates both in the speaker and in the picture in accord with the noises produced in the studio. This is after the set has been on an hour or more. If I press down gently on the station switch or tuning control, it stops for about 15 minutes then gradually starts vibrating again.—H. Ambler (Morecambe).

The fault appears to be a poor contact on the tuner springs. Remove the cover of the tuner unit; thoroughly clean the contact surfaces using a reliable switch cleaner and lightly smear with Vaseline. It should not be necessary to re-tension the springs to improve the contrast.

#### DEFIANT TR 1252/CPT

I would like to convert this set to receive channel 11. At the moment I can receive BBC only. I have not been able to find the I.F. and would appreciate any suggestions.—R. Bidde (Ipswich).

I.F.—sound  $10.5\text{Mc/s}$ , vision  $14\text{Mc/s}$ , suggested tuner unit, Cyldon U10L. The R.F. plug of the above unit replaces the rear right side 10F1, the mixer, or I.F. plug, replaces the second 10F1 (on the right of the triangular station tuner).

#### DECCA 141

This is a projection set and it goes out of focus every few minutes. I have changed the video amplifier, line output valve, cathode follower, the focus control and had the EHT unit overhauled. This tube is not yet 12 months old and the picture is good when in focus.—F. Powell (Swinton).

If the picture size varies at the same time (as the focus variation) check 560k-470k—2.2M resistor under the EHT unit. If there is little variation of picture size, there will almost certainly be some other indication as the current through the focus coil depends upon the receiver current (frame timebase etc.) except for the tube protection circuit valves V19-20 (6SN7). Examine the screen carefully for signs of variation other than focus.

#### PILOT CV84

The C4BM tube is in need of replacement and I have contemplated substituting this for a MW36-24. Would it be in order to supply the V1 from the top end of R87 through 100k and decouple with a  $0.1\mu\text{F}$  condenser? The frame linearity is poor (cramped at the top and stretched at the bottom) with full scan. I have taken several readings of resistance and voltage, the line transformer (b-c) being  $20\Omega$ . I have changed V8 and the voltage readings are anode 100, screen 80 after substitution. Anode voltages of V9b and V17a are 50 and 320 respectively. The voltage across C71 is 240.—K. Clark (Croydon).

Our component references are those of the makers; hence we must quote components according to the circuit. An MW36-24 can be fitted, the first anode being supplied via a resistor and  $0.1\mu\text{F}$  from the junction of the width coil,  $0.05\mu\text{F}$  and 3.3k (boosted H.T. line). Check 1M to frame linearity, both  $0.1\mu\text{F}$  capacitors.

#### PHILIPS 1427U

The vertical hold on the above set is very critical. I manage to stop the slipping after playing with the hold control, but the picture will not keep steady and jumps from the bottom. After about half an hour it loses  $\frac{1}{2}$ in. in height. I have replaced all the ECL80 valves.—J. Simpson (Blackburn, Lancs.).

We would advise you to check for leakage the  $1000\text{pF}$  coupling condenser from the anode of the pentode sync separator ECL80 to the pentode frame clipper ECL80 grid.

Also check by replacement the 1.2M resistor in series with the frame hold control. View with suspicion all the little  $1/10\text{W}$  resistors around the stage as these have a habit of changing their values without warning or indication.

### QUERIES COUPON

This coupon is available until AUGUST 22nd, 1960, and must accompany all Queries sent in accord with the notice on page 583.

PRACTICAL TELEVISION, AUGUST, 1960

**HOLIDAY ACCOMMODATION**

TORQUAY, "Springfield," Collaton Road, B. and B., 12/6. Parking.

**SETS & COMPONENTS**

**REBUILT TELEVISION TUBES**—12in. £5; 14in. £5/10/-; 17in. £8/10/-. Twelve months' guarantee. 10/- carr.  
**BRAYHEAD TURRET TUNERS**—£6/19/6. Carriage paid. State coils.  
 All types BBC and ITA AERIALS.  
**AIRSPACED COAXIAL CABLE** from 6d. per yard. **TELEVISION SPARES AND EXACT REPLACEMENTS.** The latest BSR, UA14 four-speed Changer £9/10/-. Carriage paid. All leading makes of **TAPE RECORDERS, TAPES, AMPLIFIERS, TAPE DECKS, RECORD PLAYERS, TELEVISIONS and RADIOS.** All new goods on Easy Hire Purchase Terms. **TRANSISTORS RED SPOT 5/6. TRANSISTORS WHITE SPOT 5/6 each. GERMANIUM DIODES 1/- each.** Stamped addressed envelope please. For inquiries and callers are welcome.

**DEVIZES TELEVISION SERVICE**  
 29-30, The Nursery, Bath Road.  
 Devizes, Wilts. Tel.: Devizes 1100.

**RECLAIMED VALVES.** All tested and perfect; modern and obsolete; huge stocks; all one price, 5/-, plus 6d. postage each, delivered by return.  
 LEWIS, 46 Woodford Avenue, Ilford, Essex.

**TELEVISIONS.**—Satisfaction guaranteed. 14in., 13 channel from £10; 17in., 13 channel from £20. All in perfect working order. Sets for the engineer from £2 each, all complete.  
 RELYON RADIO 439, Katherine Rd., Forest Gate, E.7.

"**HEATHKITS**" can now be seen in London and purchased on easy terms. Free brochure. **DIRECT TV REPLACEMENTS LTD.** 138, Lewisham Way, S.E.14. Tideway 6666.

**TAPE RECORDERS**

Build your own with the famous COLLARO "Studio" Tape Transcriber. 3 speeds, 3 motors. Record and erase heads and space for third head. Fitted to mounting board with neon indicator, 7in. spool and tape. 15.10.0  
 COLLARO "Conquest" 4-speed auto changer with template 6.19.6  
 COLLARO 4TR/200 4-speed 12in. Record Transcriber 15. 0.0  
 5 valve, 5 watt amplifier made specially for the "Studio" Tape Transcriber, with matching knobs, superimpose switch, bar magic eye, etc. 10.10.0  
 Additional heads for Stereo or Monitor 2.10.0  
 Complete cabinets available.

**TELEVISION TUBES**

12in. MW 31-74 etc. . . . . 5.10.0  
 14in. MW 36-24 etc. . . . . 6. 0.0  
 17in. MW 43-69 etc. . . . . 7.10.0  
 21in. MW 53-80 etc. . . . . 8.10.0  
**WITH MANUFACTURERS' 12 MONTHS' GUARANTEE**

**MOST OTHER TYPES AVAILABLE**  
 Carriage 10/-. Send £2 with order for immediate dispatch. Balance over six months.

**Cathode Ray Tube Service**

35 BROOMWOOD ROAD  
 T. PAUL'S CRAY, Kent, Orpington 21285

**RATES:** 4/- per line or part thereof; average five words to line, minimum 2 lines. Box No. 1 - extra. Advertisements must be prepaid and addressed to Advertisement Manager, "Practical Television," Tower House, Southampton St., London, W.C.2.

**SETS & COMPONENTS (continued)**

**New Tubes**

	2 Years' Guarantee	1 Year Guarantee
12 in. MW31-74	—	£5.5.0
14 in. MW36-24	£10.10.0	£6.6.0
17in. MW43-64/69	£12. 0.0	£8.0.0
17 in. CRM	£13.10.0	£9.0.0

Carriage 7/6

**LINE OUTPUT TRANSFORMERS**

Direct Replacements for 500 sets.  
 Baird, T23, T163 . . . . . 53/-  
 T164, T167, T172, 2014, 1712 . . . . . 60/-  
 Bush, TV 11A, B; 12A, B; TVF 12A TUG 12A, B; TRG 12A, B . . . . . 45/-  
 TV12AM; TV22, 24; TRG24, TUG24 . . . . . 60/-  
 Cosoro, 930, 931, 933, 934, etc. . . . . 80/-  
 Ecko, T346, T313-114; T161, 164; T22, 231; TSC311, etc. . . . . 55/-  
 Ferguson, 841, 2, 3; 941 to 945 . . . . . 55/-  
 990T-998T; 103-145T; 203-246T . . . . . 66/6  
 Ferranti, 14T3, 17K3, 17T3 . . . . . 45/-  
 14T2, T1205, T1215, T1225, T1325, 14T6, T1415, T1425, T1505, T1825 . . . . . 65/-  
 G.E.C. and H.M.V. mostly 55/- to 60/-  
 Invicta, T108 to T110 . . . . . 52/-  
 T101-104; T114-126; T133-142 . . . . . 60/-  
 Murphy, V114C, V116C, V118C . . . . . 45/-  
 V120C, V180, V178, V200, V202C . . . . . 57/6  
 Philips, 1114 UF/UM, 1115 U, 1437 U, 1446 U, 1726 U, 1746 U, 1747 U . . . . . 65/-  
 383A, 463A, 563A, 683A . . . . . 60/-  
 Pyc, LV30, 16T, CS17, etc. . . . . 50/-  
 C1M4, V4, VT4; V7, V17; VT17 . . . . . 60/-  
 Add 2/6 post. S.A.E. with enquiries

**Westway Radio**

5 Westward Way, Harrow, Middlesex

**TV TUBES.** Factory rebuilt. Top quality with a brand new gun assembly, 12 months' guarantee. All types and sizes up to 17in. £5/10/-. Carriage 12/6. R. HAINSWORTH (Dept C-4), 31 Alredale College Mount, Undercliffe, Bradford 3, Yorks.

**BOURNEMOUTH**

**NATIONAL RADIO SUPPLIES**  
 66 HOLDENHURST RD.

Tel.: 25232

Television Tubes, 12 month written guarantee, £6.19.6 and 10/- allowed on your old tubes. Carr. paid. 3 Element ITV and BBC dipole combined wall fixing, 34/6 and 4/6 carr. Complete range of capacitors, resistors. Hi-Fi radiogram chassis, amplifiers motors and pick-ups. stereo and mono.

Bournemouth's Hi-Fi and constructors' centre.

**NATIONAL RADIO SUPPLIES**  
 BOURNEMOUTH

**SETS & COMPONENTS (continued)**

**TV SPARES**  
**LARGEST RANGE OF NEW AND USED SPARES**

Line Outputs our Speciality. Used from £1. New from 45/-. Also breaking hundreds of TVs for Spares. All Coils, Transformers, Chassis, Valves, etc. Send S.A.E. for immediate quote.

**NEW and USED VALVES.** Used from 2/6 each. Please state type required.

**TV BARGAINS**  
 Working from £5. Chassis from 50/-. Callers Welcomed.

**Television Consumer Services LTD.**

23 BROCKLEY CROSS, S.E.4  
 Phone: TIDeway 5394

and at 112 CAMBERWELL ROAD, S.E.5  
 Phone: RODNEY 7917

Telephone Orders Sent Same Day C.O.D.

**TV TUBES** from stock. 17in. new gun £4/15/-, new gun and guaranteed, £5/15/-. 12 months' guarantee. **TV ELECTRIC & CYCLE CO.** 1, High Street, Chalvey, Slough, Bucks. Tel.: Slough 21860.

**AERIALS AT TRADE PRICES**

For Example **DOUBLE FIVE ARRAY** Band III COSTS ONLY 60/-

Band III Self-contained Pre-Amplifiers, Only £3.15.0. Band III Converters, 100/- Turret Tuners, 94/- Complete Rebuilt TV Tubes from £5. Revacuumed ones. All Sizes, £2.10.0. All Tubes are Guaranteed. Super Low-loss Coaxial Cable, 1/1 yd. Standard, 6d. yd. Diplexers, 8/8 each. S.A.E. FOR FULL LISTS.

G. A. STRANGE, Broadfield, North Wraxall, Nr. Chippenham, Wilts. Tel.: Marshfield 236.

**TV TUBES.** factory rebuilt (re-gunned), fully guaranteed, 14in., £5, 17in., £6, p and p 10/-. 24, Bristol Road, Brighton.

**THE Television Tube Shop**

**Television Picture Tubes**

	£.s.d.
Genuine 10in. Emiscope 3/16	4. 0.0
12in. MW 31-74 and CRM 121	5.10.0
14in. MW 36-24 and CRM 141	6. 0.0
15in. CRM 152 and CRM 153	6.10.0
17in. MW 43-64 and CRM 171	7. 0.0
21in. MW 53-80 and CRM 212	8.10.0

ALL with makers' 12 months' guarantee. Send £2 deposit for immediate dispatch.

**TAPE RECORDERS**

Genuine Collaro 3-speed "Studio" Tape Transcribers mounted on 7-ply base with neon indicator, counter, 7in. spool and tape. Best buy in Britain . . . . . 15.15.0  
 With pre-amp fitted ready to plug in to radio pick-up and play . . . . . 16.15.0  
 5 watt amplifier designed for the "Studio" with 5 valves, power pack and 8X5 speaker . . . . . 12.10.0  
 Extra heads for stereo or monitor . . . . . 2.10.0  
 Collaro Conquest 4-speed auto-changers . . . . . 6.15.0  
 Collaro 4TR/200 4-speed 12in. record transcribers . . . . . 15. 0.0  
 Valves! Valves! Valves! . . . . . 5.0  
 Cabinets and everything else for the home constructor available from  
 48 Battersea Bridge Rd., London, S.W.11  
 BA/Tersea 6859 or Dial 662 1285

**SETS & COMPONENTS** (continued)

**H.P. on Regunned C.R.T.S.**  
**At No Extra Charge**  
**12 months' guarantee**

12" & 14"	£3.10.0
17"	£4.10.0
21"	£5.10.0

Phone or Call only:  
 Rod 7778  
**P. J. F. Andrews**  
 61-63 ROSEMARY RD.  
 LONDON, S.E.15

**LINE OUTPUT TRANSFORMERS:**—Ferguson 991 to 997, 60/-; Pye V4, VT4, V7, VT7, 57/6; Pye CTM17S and F, CW17 and 21S, CTL58P, 55/-; HMV 1824 to 1827, 58/6. Add 2/6 p.p. Other types supplied (7-10 days). State requirements s.a.e. please. MUSCATT, 9, Joydon Drive, Chadwell Heath, Romford, Essex.

**REBUILT TV TUBES**

Fully Guaranteed  
 12 months  
 All makes—12" to 21"

**Blane & Martin Electronics**

Sandown Lane, Liverpool

DETAILS ON REQUEST. Tel. SEF. 3428

**AERIALS.** Combined BBC dipole plus 3 element ITV with fittings 34/6 plus 4/6 post. TV Tubes 12 months' guarantee £8/10/6 post paid all sizes. Trade supplied. **NATIONAL RADIO**, 66, Holdenhurst Road, Bournemouth 25232.

**C. EDWARDS**

1070 HARROW ROAD  
 LONDON, N.W.10  
 LADBROKE 1734

Offers S/H TV in First-class Condition.

12in. £5. 0.0  
 14in. £7.10.0  
 17in. £15. 0.0  
 all 5 channel  
 + 15/- carriage

**Guaranteed VALVES**

10F1, 10/-; 10C2, 7/6; 20D1, 6/-; 6F1, 5/-; SP61, 7/-; 6K25, 8/-; 20P1, 10/-; PZ30, 10/-; PL33, 7/-; ECL80, 8/-; EB91, 6/-. Plus 6d. post.  
 S/H. 12in. Tubes, 50/- plus 7/6 post.

**FERGUSON, EKCO**



**SETS & COMPONENTS** (continued)

17 INCH tubes £5. new guns, all sizes available, guaranteed. **STAR TUBES**, Brief Street, Bolton.

**MULLARD TUBES**, reclaimed, 6 months' guarantee. 9in., 30/-, 12-14in., 59/6, 17in., 79/6. All picture tested. **FITTED FREE**. Picture shown to callers. Other makes, types, cheap. Salvaged spares for modern and obsolete sets. Prices from: LCT 17/6. POT 7/6, Osc. Tr. 6/-, Mains Tr. 10/-. Valves 1.000 types in stock. EF91, KB91, 6J5, 2/6, EF80, 10P1, UF42, 3/6. Save money. Send a S.A.E. with enquiries or for free list. "ST. JOHN'S RADIO," 156, St. John's Hill, S.W.11. (BAT9838)

**FOR SALE**

**VALVE CARTONS** at keen prices. Send 1/- for sample and list. J. & A. **BOXMAKERS**, 75a, Godwin Street, Bradford 1.

**100 BAYS** of brand new adjustable steel shelving. 72in. High x 34in. wide x 12in. deep. stove enamelled, dark green, sent unassembled, six-shelf bay. £3/15/-. Sample delivered free. Quantity discounts. N. C. **BROWN LTD.**, Eagle Steelworks, Heywood, Lancs. Tel.: 69018.

**UNREPEATABLE VALUE!**  
 29 Gns. NOW ONLY—18 Gns.

**COMPLETE TAPE RECORDER**  
 Famous manufacturer. Huge purchase allows us to offer at this amazing price: beautifully styled rexine covered cabinets—Colours: RED, GREY and BLACK. Ample storage space for 4 tapes. Mike and lead incorporating the new B.S.R. Tape Deck. Size: 14 1/2 x 14 1/2 x 7 1/2 in.; light weight, 21 lbs. 5 1/2 in. standard tapes, playing time 1 1/2 hours. Microphone 27/6d. extra. Post, ins. & carr., 12/6.

**P.P. COMPONENTS LTD.**  
 219 ILFORD LANE, ILFORD, ESSEX  
 (Mail Order Only)

**SERVICE SHEETS:** also Current and Obsolete Valves for sale. **JOHN GILBERT RADIO**, 20, Extension, Shepherd's Bush Market, London W.12 (Phone: SHE 3052).

**1,000 TELEVISIONS**, all makes, from £3 working, 10/- not. Callers only 9 till 6, including Sats. 39, Whitehorse Lane, Stepney, London.

**TELEVISIONS**

All sizes including Projections. Require attention from £3. In working order:—12in. BBC from £5.

12in. and 14in. BBC/ITA from £10. Regunned CRT £6 extra. 17in. from £25. Send for Lists. Carriage Paid.

**CADMANS**

SERVICE DEPARTMENT  
 BRYAN STREET, HANLEY  
 STOKE-ON-TRENT

**WANTED**

**NEW VALVES WANTED.** — EY31, ECL80, PCCP4, PCF80, PCL83, PL81, PCL82, PY81, R19, U801, 30P4, etc. Best cash prices by return. **DURHAM SUPPLIES**, 175 Durham Road, Bradford 8, Yorkshire.

**WANTED.** Service Sheets. No quantity too large or too small, highest prices paid. **SULTAN RADIO**, 29, Church Road, Tunbridge Wells, Kent.

**WANTED** (continued)

**A PROMPT CASH OFFER** for your surplus Brand New Valves, Speakers, Components, Test Instruments etc. **R.H.S.**, 155 Swan Arcade Bradford 1.

**BEST PRICE** paid by return for new Valves and equipment. **STAN WILLETTS**, 43, Spion Lane, West Bromwich, Staffs. Tel: WES. 2392.

**NEW TV VALVES WANTED.** Send valves, cash by return to: P. J. F. **ANDREWS**, 81-83, Rosemary Road, London, S.E.15.

**WANTED—VALVES.** Modern TV and Radio types. Large or small quantities. Box No 22.

**EDUCATIONAL**

**STUDY RADIO, TELEVISION AND ELECTRONICS** with the world's largest home study organisation. **Brit.I.R.E.:** City and Guilds; R.T.E.E. etc. Also Practical Courses with equipment. No books to buy. Write for **FREE Prospectus** stating subject to **I.C.S.**, Intertext House, Parkgate Road, (Dept. 516), London, S.W.11.

**"HOW AND WHY"** of Radio and Electronics made easy by a new, non-maths, practical way. Postal instructions based on hosts of experiments and equipment building carried out at home. New Courses bring enjoyment as well as knowledge of this fascinating subject. Free brochure from Dept. 12, P.T. **RADIO-STRUCTOR**, 40, Russell St., Reading, Berks.

**INCORPORATED** Practical Radio Engineers' home study courses of radio and TV engineering are recognised by the trade as outstanding and authoritative. Moderate fees to a limited number of students only. Syllabus of Instructional Text free. "The Practical Radio Engineer" journal, sample copy 2/-, 6,000 Alignment Peaks for Superhets, 5/9. Membership and Entry Conditions booklet 1/-, all post free from the **SECRETARY**, I.P.R.E., 20, Fairfield Road, London, N.8.

**★ LEARN RADIO & TV SERVICING for your OWN BUSINESS/HOBBY**

● by a new exciting no-maths system, using practical equipment, recently introduced to this country.

**FREE Brochure from:— RADIOSTRUCTOR**

**DEPT. G78, 40 RUSSELL STREET READING, BERKS. 8.60**

(continued overleaf)

**PUBLIC APPOINTMENTS**

**MEN** with a knowledge of the basic principles of Radio and Radar are required in the Meteorological Office. After short initial training, those appointed will maintain and operate radio and radar equipment, including facsimile apparatus. Opportunities to serve overseas and in the United Kingdom. Starting salary for Radio (Meteorological) Technician, London, £890 at 25 or over, rising annually to £820, subject to deductions for each year below age 25. Provincial salary £40 to £50 lower. Good promotion prospects, overtime, allowances, night duty, etc. Apply to: **METEOROLOGICAL OFFICE, (M.O. 10R/M/T)** Victory House, London W.C.2.

**SITUATIONS VACANT**

**PHILIPS ELECTRICAL LIMITED** (Medical X-Ray Division) require an **ENGINEER** for the service and installation of X-Ray equipment. Candidates with O.N.C. (Electrical) or Electronics experience would be considered. Applications with full details should be addressed to the Personnel Officer, (Medical X-Ray Division), 45, Nightingale Lane, Balham, S.W.12.

**PHILIPS ELECTRICAL LIMITED**

(Medical X-ray Division)

**45 Nightingale Lane  
Balham, S.W.12**

A vacancy has arisen for an Assistant in the Installation Planning Department. Knowledge of electronics and drawing office experience desirable. Capable of working on own initiative, training will be given. Aged 18/23. Write giving full details of experience, etc. to the Personnel Officer, at the above address.

**ELECTRONIC WIREMEN** who are capable of wiring prototype units from circuit diagrams are required for a special products section in the T.V. transmission (studio and control equipment) laboratory. Previous TV experience not essential, but applicants must have been employed on circuitry or similar complexity and be able to work with the minimum of supervision. Good prospects for candidates of ability. Applications, quoting "KRR/EWT" should be addressed to the Engineering Personnel Officer, **PYE T.V.T. LTD., Cambridge.**

**SERVICE SHEETS**

**SERVICE SHEETS.** Radio, T.V., 5 000 models. Lists 1/-. S.A.E. enquiries. **TELRAY, 11, Maudland Bk., Preston.**

**SERVICE SHEETS.**—Huge stock at 4/- ea. List 1/- Immediate delivery. **GLOBE SUPPLIES, 33, Fairfield Close, Sidcup, Kent.**

**SERVICE SHEETS (continued)**

**SERVICE SHEETS** for sale, all types from 1/- each, with free fault-finding guide. 125 Radio/TV Service Sheets, covering 370 popular models 20/- S.A.E. lists/enquiries. **HAMILTON RADIO (T), 237, Sedlescombe Rd. N., Hastings.**

**SERVICE SHEETS.**—We have the largest stock of Radio and TV Sheets in the country for sale at 4/- ea. 1960 Radio and Television Service Sheet List Now Ready. 1/-. Also Manuals for sale or hire. List 9d. S.A.E. please. Mail Order Only. **S.P. DISTRIBUTORS, 11, Old Bond Street, London W.1.**

**SERVICE SHEETS.** TV 4/- ea. Radio 3/- ea. List 1/-. All orders despatched on day received. C.O.D. if required. Also manuals for sale and hire. **SULTAN RADIO, 29 Church Road, Tunbridge Wells, Kent.**

**SERVICE SHEETS.** TV 2/6 each, radio 2/- each. Post free. **DARWINS, 45, Shaw Street, St. Helens, Lancs.**

**SERVICE SHEETS.** Largest stock Radio and TV Service Sheets North London. 4/- each with S.A.E. State make and model no. Circuit diagram only 2/6. Also Manuals for sale or hire. Radios over 20 years our speciality. All enquiries S.A.E. please. **WYNDSOR TELEVISION, St. Albans Road, Barnet, Herts.**

**FAULTFINDER FIBES (TV)** showing common faults that each receiver is prone to and other useful servicing information 2/- each. List 9d. plus postage. **S.P. DISTRIBUTORS, 11, Old Bond Street, London, W.1.**

**“AS-NU”  
Regunned  
TV Tubes**

Supplied from stock, and despatched by British Railways same day.

**COMPLETE NEW GUNS**

fitting in every tube and fully guaranteed for TWELVE MONTHS.

		Mullard	Mazda
12 in. ...	...	£4.10.0	£5.0.0
14 in. ...	...	£4.15.0	£5.10.0
15 in. ...	...	—	£6.5.0
16 in. ...	...	£6.10.0	—
17 in. ...	...	£5.15.0	£6.0.0
21 in. ...	...	£8.10.0	£8.10.0

Plus 10/- Carr. & Ins.

Other types available. Please contact:

**J. P. WRIGHT**

1c Shotton Street, Doncaster

Sole Distribution Agent

'Phone: DON 2636 or 66252

**EDDY'S (Nottm.) LTD.**

172 ALFRETON ROAD, NOTTINGHAM

New or Surplus Guaranteed and Tested Valves by Return of Post

ID5	7/6	12AH8	9/6	ECH42	8/3
1H5GT	9/6	12K7	5/3	ECL80	7/6
1L4	3/6	12Q7	5/3	ECL82	9/11
1NSGT	9/6	25A6G	6/11	EF36	3/-
1R5	6/-	25L6GT	8/11	EF37	8/3
1S5	4/9	25Z4G	7/6	EF40	13/3
1T4	3/11	35 W4	6/6	EF42	7/3
3Q4	7/-	954	1/6	EF86	10/-
354	6/3	955	3/6	EF91	3/6
3V4	7/-	956	2/6	EL42	9/3
3Q5GT	8/6	AZ31	8/9	EL84	6/6
5U4G	5/-	CL33	12/3	EY51	8/6
6B8G	2/11	DAF96	6/11	EY86	7/11
6BA6	5/11	DF96	6/11	EZ40	6/6
6BE6	5/11	DK92	7/11	EZ80	6/-
6BJ6	5/11	DK96	6/11	PCB84	7/3
6C4	3/3	DL96	6/11	PCF80	7/-
6C6	4/-	EB41	6/11	PCLB2	7/6
6F1	6/6	EB91	3/6	PCLB3	11/3
6I7G	5/-	EB41	7/9	PL81	9/-
6K7G	1/11	ECC40	19/11	PL82	7/3
6K8G	5/6	ECC81	5/3	PL83	7/3
6SG7M	4/9	ECC82	6/-	PY80	6/11
6SN7GT	4/3	ECC84	8/3	PY81	6/3
6V6G	4/11	ECC85	7/11	PY82	6/6
6V6GT	6/-				
6X4	5/11				

**Nife Accumulators.** Size 3 x 2½ x ¾ in. 7 amp hrs. 1.25 v. Weight 13 oz., 1/11 ea. P. & P. 1/6 one only, add 9d. each cell.

**Handmikes.** Carbon, 3/11. Post 1/9. **Dimmer Switches.** Ideal for train speed regulators, 1/11. Post 9d. **Headphone Cords.** High Quality 6ft. lengths, 1/11. Pair post 6d. **2,000 mfd. Condensers.** 6 volt working, 1/6. Post 6d. **Germanium Diodes.** 9d. each, 8/- dozen. Post 9d. **Throat Mikes.** 1/- each. Post 6d. Could be used for electrifying mus. instruments. **Variable Condensers.** Small twin gang Built-in slow motion drive, 8/11. Post 1/6.

**Build your own  
CAR RADIO!**

★ 7 Transistors ● Long and Medium Waves ● Two Watts Output ● R.F. Stage and Automatic Gain Control



**10 ½  
Gns.  
P & P  
5/- extra**

6 or 12 volts (state which)  
Supplied with full instructions  
Size 7 ¾ x 7 ¾ x 2 ½ in.  
**SPEAKER, extra 1/11**

Transistors. Red Spot, 3/11. White Spot, 4/11. Post 6d. **Luxembourg Expanding Aerials.** Complete and easy to fit. No technical knowledge required. Greatly improves reception, 3/11. Post 6d.

Any parcel insured against damage in transit for only 6d. extra per order. All uninsured parcels at customers' risk. Postage and packing 6d. per valve extra, over £3 free. C.W.O. or C.O.D. only. C.O.D. charge 3/- extra.

S.A.E. with enquiries.

**ANOTHER BARGAIN FROM DUKE & CO. JUST LOOK AT THIS!**

**SUMMER SALE BARGAIN!**

**17" TV's COMPLETE 19 Gns.**

Cash or Terms over 20 weeks (NO interest charged). Initial payment £1.07 and 19 weekly payments of 19/11. Carr. and Ins. 30/-.  
ITV/BBC. Beautifully styled polished cabinets. These are table models with the option of contemporary legs fitted (2 gns. extra).  
17in. rectangular tube guaranteed for 12 months. Valves and chassis guaranteed for 3 months. (Chassis salvaged but reconditioned.) Where possible personal collection is advised.

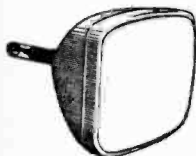

**REPLACEMENT, REBUILT TV Tubes**

**12 Months Guarantee**

TERMS AVAILABLE OVER 20 WEEKS

21 in. TUBE .. £8.10.0 **£2** allowed on old tube  
17 in. TUBE .. £7.10.0 **£1** allowed on old tube  
12, 14, 15 in. TUBES £5.10.0 Carr. and Ins. 15/6. **£1** allowed on old tube

**★ 29 Gns. NOW ONLY 18 Gns.**

**COMPLETE TAPE RECORDER UNREPEATABLE VALUE!**

Famous Manufacturer. Huge purchase allows us to offer at this amazing price. Beautifully styled, rexine covered cabinets, colours—RED, GREY, BLACK. Storage space for 4 tapes, Mike and Lead. Incorporating the new B.S.R. Tape Deck. LOOK AT THESE EXPENSIVE FEATURES. Controls. Record/Playback switch and rewind with interlocking device to prevent accidental erasure. Tone and volume controls. Super impose and electronic eye. Ample power output 3.5 watts. Small overall size—14½ x 14½ x 7½ in. Lightweight, only 21 lb. Playing time 1½ hours. 5½ in standard tape. Microphone 27/6 extra. Tapes 19/9. Terms available. Carr. & Ins. 12/6.

**HOME RADIO 79/6**  
**A.C. or Universal**

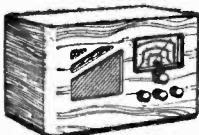

mains. 5 valve octal superhet. 3 w/band receiver. In attractive polished cabinet. Dimensions 9½ x 18½ x 11½ in. Carr. and Ins. 4/6. Terms available

**EXTENSION SPEAKERS**

Polished oak cabin-19/9 fitted with Bin. P.M. Speaker, Complete. Switch and Flex included. Ideal for kitchen, shed, etc. Carr. and Ins. 3/9.

**SEND FOR A FREE CATALOGUE**

No deposit. Interest free. 20 or 36 weeks to pay.

**DUKE & CO. (London) LTD.**

Dept. E.8  
621/3 Romford Road, Manor Park, E.12. ILF 6001/3

**TV TUBES**

Factory Reprocessed Completely as new

New Mullard, Mazda or RCA Guns

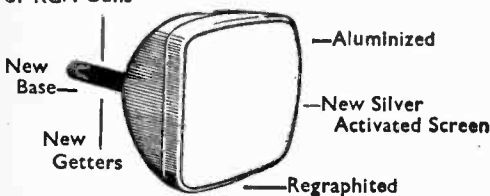

**COMPLETELY NEW TUBES EXCEPT THE GLASS**

ALL MAKES AND TYPES FROM STOCK	
12" .. .. .	£5 10 0
14" .. .. .	£5 19 0
15"—17" .. .. .	£6 10 0
21" .. .. .	£8 10 0

12 months NEW tube guarantee.

C.W.O. or C.O.D. Carr. & ins. 7/6 (passenger) 20/- refunded if you wish to return your old tube.

The Finest Tubes. The Fastest Service

**LAWSON TUBES**  
156 PICKERSLEIGH ROAD, MALVERN WORCS. MAL 3798

**Multi-Purpose VALVE FILAMENT TESTER**

**Model VT41**

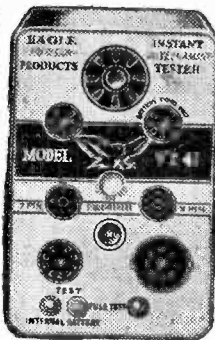

- Pocket size
  - Battery operated
- GIVES INSTANT CHECK OF:
- ★ All TV and Radio Valves and Fuses.
  - ★ All pilot lamps.
  - ★ Circuit Continuity.
  - ★ Built-in 7 and 9 pin valve straighteners.
  - ★ Built-in Battery Test.

With this revolutionary instrument you can test all current Valves, Fuses, Continuity and other radio parts. All components tested are shown "good" or "faulty" on panel indicator.

Finished in black hammer case with gold front panel. Complete with 30/- internal batteries, full instructions, and ready for use.

From your local dealer or if in difficulty order direct:

**EAGLE PRODUCTS** (Dept. P.T.5.)  
**EAGLE WORKS, COPTIC ST., LONDON, W.C.1.**

# VALVES SAME DAY SERVICE

**NEW! TESTED! GUARANTEED!**

**SETS** 1R5, 1S5, 1T4, 3S4, 3V4, DAF91, DF91, DK91, DL92, DL94, any 4 for 19/6  
 DAP98, DP98, DK98, DL98 4 for 27/6  
 6K7G, 6K8G, 6Q7G, 6V6G, 6X5G, or 5Y3G :: :: :: 5 for 27/6

1A7GT 12/-	6L18 12/3	25Z4G 7/6	EBF89 8/9	EZ41 7/6	R19 13/6
1D5 8/-	6LD20 8/-	25Z6GT 9/6	EBL21 20/6	EZ80 6/3	T41 15/6
1H5GT 10/-	6F25 9/-	30C1 7/3	EC92 11/-	EZ81 7/-	U25 13/6
1N5GT 10/-	6Q7G 6/9	30L1 7/9	EC81 5/9	FW4/500 8/-	U50 11/-
1R5 6/-	6Q7GT 9/6	35L6GT 9/6	EC82 6/6	GZ32 9/-	U52 6/9
1S4 9/-	6SL7GT 6/3	35Z4GT 6/6	EC83 7/-	KT33C 7/-	U76 5/3
1S5 5/3	6SN7GT 4/9	35Z5GT 8/6	EC84 8/9	KT41 14/6	U78 6/-
1T4 4/-	6U4GT 11/-	50CD6G 28/9	EC85 8/3	KT44 9/-	U78 9/-
1U5 6/6	6V8G 5/-	50L6GT 8/9	ECF80 9/6	KT61 10/-	UABC30 7/9
3A5 10/6	6V8GT 6/6	185BT 25/-	ECF82 9/6	KT63 6/6	UAF42 9/6
3Q4 7/6	6X4 5/-	AZ31 9/6	ECH35 20/6	KT71 8/6	UBC41 7/9
3S4 6/-	6X5GT 5/6	B36 8/9	ECH42 8/9	MX40 7/6	UBF80 9/6
3V4 7/-	7B7 7/6	CL33 13/-	ECH81 8/-	N18 7/6	UBF89 8/-
5U4G 5/3	7C5 7/6	DAC32 10/-	ECL80 7/3	N18 7/6	UBL21 20/6
5V4G 6/6	7C8 7/6	DAF91 5/3	ECL82 10/-	PCC84 7/9	UCC85 7/6
5Y3GT 9/9	7H7 7/6	DAF96 7/6	EF35 4/6	PCC89 12/-	UCC80 14/-
5Z4G 7/9	7S7 9/9	DC90 10/6	EF41 8/3	PCF80 7/3	UCH21 20/6
6AL5 3/9	7Y4 8/-	DF33 10/-	EF42 9/6	PCF82 8/6	UCH22 8/-
6AM6 3/6	10C1 14/6	DF91 4/-	EF80 8/6	PCF82 8/6	UCH81 8/-
6AQ5 6/-	10C2 17/6	DF96 7/6	EF80 8/6	PCF82 8/6	UCL82 10/9
6AT6 7/3	10F1 15/6	DH78 5/6	EF88 10/6	PCL84 11/-	UCL83 14/-
6BA6 6/-	10F13 14/6	DH77 7/3	EF89 7/6	PEN44 11/-	UF41 8/9
6BB6 6/-	12A18 10/-	DK32 12/-	EF91 3/6	PEN36G 8/6	UF42 6/6
6BH6 5/9	12AT7 5/9	DK91 6/-	EF92 4/6	PEN45 8/-	UF89 7/-
6BJ6 5/9	12AU7 6/6	DK92 8/6	EL32 10/-	PEN46 5/6	UL41 8/-
6BR7 9/9	12AX7 7/-	DK96 7/6	EL33 9/-	PL36 11/6	UL84 7/6
6BW6 8/-	12BA6 8/-	DL35 10/-	EL41 8/6	PL38 14/6	UR10 8/-
6BW7 6/6	12KGT 5/6	DL92 6/-	EL42 8/6	PL81 9/6	UY21 11/3
6CD6G 22/6	12K8GT 11/6	DL94 7/6	EL84 7/-	PL82 7/6	UY41 6/6
6F1 14/6	12Q7GT 5/6	DL94 7/6	EL84 7/-	PL83 7/6	UY85 6/6
6F6G 6/6	12Z3 7/6	DL96 7/6	EM30 9/-	PY32 12/-	VP4B 9/6
6F13 12/6	14S7 16/9	ELC80 7/-	EM80 9/-	PY80 7/6	VP41 6/-
6F14 17/6	19AQ5 7/-	EAF42 8/6	EM81 9/-	PY81 7/6	W76 5/6
6KTG 2/6	20F2 17/6	EB91 3/9	EM84 10/-	PY81 7/6	W77 4/6
6K7GT 5/9	20L1 17/6	EBC33 5/-	EY51 8/6	PY83 7/9	X78M 11/6
6K8G 6/9	25A6G 8/-	EBC41 8/6	EY86 7/9	PZ30 17/-	Z77 3/6
6L1 15/-	25L6GT 9/-	EBF80 8/-	EZ40 6/9		

## READERS RADIO

24 COLBERG PLACE, STAMFORD HILL LONDON, N.16 STA. 4587

## NEW 7th EDITION TELEVISION EXPLAINED

by W. E. Miller

revised by W. Spreadbury

12/6 Postage 1/-

TRANSISTOR PROJECTS. 23/-

Postage 1/-

TV FAULT FINDING. A Data Pub.

5/-, Post 6d.

A BEGINNER'S GUIDE TO TELEVISION. By F. J. Camm. 7/6.

Postage 6d.

TELEVISION ENGINEERS' POCKET BOOK. By J. P. Hawker.

12/6. Postage 8d.

MODEL ANSWERS, C. and G. of London. Telecommunication Principles A and B. 7/6 each. Postage 6d.

THE RADIO AMATEUR'S HANDBOOK. By A.R.R.L., 1960 ed. 32/6.

Postage 2/-.

RADIO VALVE DATA. Compiled by "WW". 5/-. Postage 9d.

NEW 1960 CATALOGUE, 1/-.

## THE MODERN BOOK CO.

BRITAIN'S LARGEST STOCKISTS of British and American Technical Books

19-21 PRAED STREET, LONDON, W.2.

Phone: PADDington 4185

Open 6 days 9-6 p.m.

## REBUILT & REGUNNED C.R.T.s

NEW ELECTRON GUNS FITTED 12 months' guarantee Despatched Same Day

ALL types available:

Mullard, Mazda, G.E.C., Emiscope, Brimar, E.E., etc.

12"	..	...	£4. 15s. 0d.
14"	..	...	£4. 15s. 0d.
15"	..	...	£5. 15s. 0d.
17"	..	...	£5. 15s. 0d.
21"	..	...	£7. 15s. 0d.

Carriage and Insurance 7/6.

We Regret the price error in our previous advertisement

Cash with order to:

**CHARLES TEMPEST CO.**  
 (Whinmoor Distribution)  
 WELTON ROAD, BROUGH  
 E. YORKS.

## TV AERIALS

Do-It-Yourself Kits Direct from Manufacturers. All Aerials pre-assembled for easy fitting.

Examples:

- S/D +5 combined BBC, ITA Loft AE, £110.0.
- S/D +5 combined BBC, ITA outdoor AE wall mounting complete, £213.6.
- H +7 combined BBC, ITA with chimney lashing equipment, £413.0.
- H +Double, 6 super fringe combined BBC, ITA with 12ft. mast and chimney mounting kit, £110.0.
- BBC loft AE 12/9. V.H.F. loft AE 11/3.
- 5 Element ITA AE for attaching to existing mast, £110.0.
- 5 Element ITA loft AE, £116.0.
- 8 Element ITA AE, £29.4.
- Coax cable semi low loss, 7d. per yard, super low loss, 1/2 per yard.
- Cross-over boxes for combining separate BBC and ITA Aerials, 9/6.
- 32ft. Garden Masts complete for erection, two sets guys, pickets, etc., with fitting instructions, £12.10.0.

Please send 6d. stamp for full list of aerials and accessories. Terms C.W.O. Orders over £4, post and packing free.

**A. & L. ARNOLD LTD.**  
 Midland Bank Chambers, Fore Street, Hertford.

**For Safety's Sake**  
 use  
**AVO Prodclips**



Safety first every time with these patented spring-loaded AVO Prodclips.

Cleverly designed for use as insulated prods, they are invaluable for reaching and holding test points which are difficult of access.

Suitable for use with AvoMeter, Multiminor and Avo Electronic Test Meter Leads.

Post Free  
**15/-**  
 per pair.

**AVO LTD** - AVOCET HOUSE,  
 92-96 VAUXHALL BRIDGE ROAD, LONDON, S.W.1.  
 Victoria 3404 (12 lines)

A MEMBER OF THE METAL INDUSTRIES GROUP OF COMPANIES

# Unrepeatable Offer

**COSSOR 10" TUBE  
 108K — BRAND NEW**

Twelve months' guarantee

**NOT A RE-GUN**

—we have a few only

**15/- each**

10/- Packing, Postage and Insurance

**HARVERSON SURPLUS  
 LIMITED**

**83 High Street  
 MERTON, S.W.19  
 CHERRYWOOD 3985/6/7**

Let **I.C.S.**  
 train YOU!



**COURSES ON:—**

**RADIO and TELEVISION  
 SERVICING ELECTRONICS  
 EXAMINATION COURSES FOR:—**

**C. & G. Radio  
 Servicing Certificate**  
 (R.T.E.B.)

**C. & G. Radio  
 Amateurs' Exam.**  
 (Amateurs' Transmitting  
 Licence)

**British Institution of Radio Engrs., etc.**

Whether you plan to have your own business, to become an electronics engineer or to take up a career in industry, an I.C.S. Course will help you to success. You learn at home in your own time, under expert tuition. Moderate fees include all books.

## LEARN - AS - YOU - BUILD

### Practical Radio Course

A basic course in radio, electronic and electrical theory backed by thorough practical training. You build a 4-valve T.R.F. and a 5-valve superhet radio receiver, signal generator and multi-tester

Other Learn-as-you-Build radio courses are available

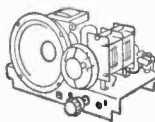

**MULTI-TESTER**  
 (Sensitivity 1,000 ohms per volt)

**5-VALVE  
 SUPERHET RECEIVER**

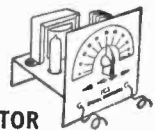

**RF/AF SIGNAL GENERATOR**

Post this Coupon **TODAY** for FREE book on careers in Radio, etc., and full details of I.C.S. Courses

**International Correspondence Schools**  
 (Dept. 164B), Intertext House, Parkgate Road,  
 London, S.W.11.

Please send book on \_\_\_\_\_

Name \_\_\_\_\_ Age \_\_\_\_\_  
 (Block Letters please)

Address \_\_\_\_\_

Occupation \_\_\_\_\_ 8-60

**INTERNATIONAL CORRESPONDENCE SCHOOLS**

**TELEVISION TUBES REGUNNED**

**12 MONTHS' GUARANTEE**

MW 3171 .. .. .	£5.10.0
CRM 123 .. .. .	£5.10.0
CRM 141 .. .. .	£5.10.0
CRM 171 .. .. .	£6.0.0
CRM 152B .. .. .	£5.10.0
MW 3524 .. .. .	£5.10.0
MW 43/89 .. .. .	£6.0.0

Carriage and Insurance 10/- extra.  
**ALLOWANCE ON OLD TUBE IF RETURNED.**

**LOUDSPEAKER UNITS**

- All Brand New
- Note the Special Prices
- All Permanent Magnet 3 ohms Impedance

24in. Square Rola C25 .. .. .	26/8
24in. Square Units by Celestion .. .. .	18/6
3in. Square Units by Celestion .. .. .	18/6
4in. Square Units by Elac .. .. .	19/6
5in. Round Units by Goodman, Celestion and Plessey .. .. .	18/6
6in. Round Units by Celestion .. .. .	17/6
8in. Round Units by Goodman, Elac .. .. .	18/6
10in. Phillips Type with tweeter .. .. .	27/6
10in. Round Units by Elac .. .. .	22/6
12in. Round Units by Plessey .. .. .	32/6
7 x 4in. Units by Plessey and Goodman .. .. .	19/6
8 x 5in. Units by Celestion and Richard Allen .. .. .	25/6
10 x 6in. Units by Goodman and Celestion .. .. .	25/6

**SPECIAL MAINS DROPPER RESISTORS**

SMD1 Philips 209U .. .. .	6/3
SMD8 Ultra Twin 50 .. .. .	5/3
SMD7 Ultra Twin 50 .. .. .	5/3
SMD15 Philips 141U and Stella ST105U .. .. .	5/3
SMD27 Pye Pifer .. .. .	6/9
SMD30 KB Rhapsody MP151/1 .. .. .	6/9

**ALPHA RADIO SUPPLY CO.**

**VALVES GUARANTEED ALL TESTED BEFORE DESPATCH**

AZ1 10/-	GZ32 12/-	3V4 8/-
AZ31 10/-	PCC84 8/6	5Y3G 9/-
DAF96 8/-	PCC85 11/8	5Z4G 4/-
DF96 8/-	PCF80 8/9	6AL5 14/-
DL96 8/-	PCL82 12/-	6F1 14/-
EAF42 10/6	PCL83 13/6	6F15 14/-
EBC33 6/9	PL36 14/6	6J7G 6/6
EBC41 8/9	PL38 26/6	6K7G 4/-
ECC31 8/-	PL81 11/-	6K93 6/6
ECC82 7/6	PL82 8/6	6K25 19/11
ECC83 9/-	PL83 9/6	6L8M 9/6
ECC84 10/-	PY82 17/11	6AM6 4/-
ECC90 12/-	PY81 8/6	6Q7G 7/6
ECP82 10/6	PY82 7/-	6V6G 6/-
ECH42 9/6	PZ30 19/11	6V6GT 7/9
ECH81 9/-	TP25 10/-	6X5GT 7/-
ECL80 9/6	U25 17/8	7B8 10/8
EP39 5/8	U26 10/-	7B7 9/-
EP41 9/6	U37 26/6	7S7 8/6
EP80 7/-	U801 29/10	7Y4 8/6
EP86 12/6	UAF42 9/6	10F1 12/6
EL33 14/-	UBC41 8/6	10P13 15/6
EL41 9/-	UCH42 9/6	12A77 7/8
EL42 10/6	UP41 9/-	12AX7 8/6
EL84 9/-	UL41 9/-	12AU7 8/6
EM34 9/6	UU8 26/6	20P1 26/6
EM80 10/-	UY1N 12/8	25A6G 10/8
EY51 9/6	UY41 7/6	25Z4 9/6
EY88 10/-	IS5 7/6	27SU 19/11
EZ40 7/6	IT4 5/6	35L8GT 10/-
EZ81 7/-	3S4 7/6	35Z4GT 8/-

Line output transformer type L04. Pye V4, V7, V14, V17; Pam 908, 909, 952, 953, 958; Invictor 118, 119, 120. Price 55/2-

**AUTOMATIC RECORD CHANGER UNITS**

Monarch UA8, 4-speed automatic record changers with Ful-FI turnover crystal cartridge, £6.19.6. Carriage 3/6.

B.S.R. Monarch UA12, 4-speed unit. Ful-FI turnover crystal cartridge, attractively styled in two colours of cream and pastel green. £8.19.6.

Collaro Conquest, 4-speed fully mixing changer complete with Studio "O" crystal cartridge, £7.19.6. Carriage 3/6.

Collaro RC457, High Fidelity 4-speed automatic record changer with turnover cartridge, £7.19.6.

Garrard RC120/D Mk.II, 4-speed unit manual control to enable records to be played singly. £8.19.6. Carriage 3/6.

**ACOS MICROPHONES**

Acos Mic 39/1, Crystal Stick Microphones for use as a hand, desk or floor stand unit for high quality recording, broadcasting and public address work. List price £5.5.0. **OUR PRICE 39/6.** With Table stand 47/6. With floor stand adaptor 52/6. Postage 1/6. **ACOS Mic 40**, as supplied with most modern tape recorders, with folding rest and 8ft. lead, response 40-6,000 c.p.s. Listed at 35/-. **OUR PRICE 25/-.**

**CATALOGUE**

Our 1961 Catalogue is now available. Please send 1/- in stamps for your copy. Trade Catalogue also available. Please apply on business letter heading.

**ALPHA RADIO TERMS.**—Cash with order or C.O.D. Postage and Packing charges extra, as follows: Order value 10/- add 1/3; 20/- add 1/9; 40/- add 2/6; £5 add 3/6. Minimum C.O.D. Fee and Postage 3/-. For full terms of business see inside cover of our catalogue. Personal Shoppers 9 a.m. to 5 p.m. Monday to Friday, Saturday 10 a.m. to 1 p.m.

**103 LEEDS TERRACE, WINTOUN STREET, LEEDS, 7.**

Introducing . . . .

**THE NEW SAPHIRE REBUILT TUBE**

—The Result of Research—

**A New Gun in every Tube—**

**Buy Direct from the Factory**

**NOW 18 MONTHS' GUARANTEE**

**12 inch £6-0-0**

**14 inch £6-10-0**

**15, 16 & 17 inch £7-10-0**

**£1 refunded on receipt of your old tube**

Carriage and insurance 10/6 extra

**★ Special terms to the trade**

**Electronic Maintenance Services**

131 St. Ann's Road, Tottenham. London, N.15  
 Telephone Stamford Hill 3267, 5555.

**TV TUBES**

**WHY USE INFERIOR TUBES WHEN WE CAN SUPPLY ALL TYPES OF REGUNNED REBUILT TUBES**

**FOR ONLY 75/-**

**12 months' Guarantee or**

**OUR FABULOUS NEW SILVER SCREEN TUBES AS USED BY LEADING TRADERS**

Replacements for—

Mullard, Mazda, Cathodeon, G.E.C., English Electric, Emiscope, Emitron.

**12", 14"—£6-15-0**

**15", 16", 17"—£7**

**21"—£8-10-0**

**24"—£10**

Carriage and Insurance on all tubes, 10/-  
 Trade Discount. 20 Weeks' Credit available  
 Please note our new address:

**Express Electronics**

40 LANDSDOWNE TERRACE  
 KELVIN BRIDGE, GLASGOW, NW  
 Phone: Wes 8436



# FREE TO AMBITIOUS ENGINEERS

— THE LATEST EDITION OF ENGINEERING OPPORTUNITIES

**Have you sent for your copy?**  
**ENGINEERING OPPORTUNITIES** is a highly informative 156-page guide to the best paid engineering posts. It tells you how you can quickly prepare at home for a recognised engineering qualification and outlines a wonderful range of modern Home Study Courses in all branches of Engineering. This unique book also gives full details of the Practical Radio & Electronics Courses, administered by our Specialist Electronics Training Division—the B.I.E.T. School of Electronics, explains the benefits of our Employment Dept. and shows you how to qualify for five years promotion in one year.

**We definitely Guarantee**  
**"NO PASS—NO FEE"**

Whatever your age or experience, you cannot afford to miss reading this famous book. If you are earning less than £20 a week, send for your copy of "ENGINEERING OPPORTUNITIES" today—FREE.

**BRITISH INSTITUTE OF ENGINEERING TECHNOLOGY** (Incorporating E.M.I. Institutes)  
 (Dept. SE/21), 29 Wright's Lane, London, W.8

**THE B.I.E.T. IS THE LEADING ORGANISATION OF ITS KIND IN THE WORLD**

**WHICH IS YOUR PET SUBJECT?**

Mechanical Eng.,  
 Electrical Eng.,  
 Civil Engineering,  
 Radio Engineering,  
 Automobile Eng.,  
 Aeronautical Eng.,  
 Production Eng.,  
 Building, Plastics,  
 Draughtsmanship,  
 Television, etc.

**GET SOME LETTERS AFTER YOUR NAME!**

A.M.I.Mech.E.  
 A.M.I.C.E.  
 A.M.I.Prod.E.  
 A.M.I.M.I.  
 L.I.O.B.  
 A.F.R.Ae.S.  
 B.Sc.  
 A.M.Brit.I.R.E.  
 City & Guilds  
 Gen. Cert. of Education  
 Etc., etc.

**PRACTICAL EQUIPMENT**

Basic Practical and Theoretical Courses for beginners in Radio, T.V., Electronics, Etc., A.M.Brit.I.R.E. City & Guilds Radio Amateurs' Exam. R.T.E.B. Certificate P.M.G. Certificate Practical Radio and Television Servicing Practical Electronics Electronic Engineering Automation

**INCLUDING TOOLS!**

The specialist Electronics Division of B.I.E.T. (Incorporating E.M.I. Institutes) NOW offers you a real laboratory training at home with practical equipment. Ask for details.

**B.I.E.T. SCHOOL OF ELECTRONICS**



**POST COUPON NOW!**

Please send me your FREE 156-page 'ENGINEERING OPPORTUNITIES'  
 (Write if you prefer not to cut page)  
 NAME.....  
 ADDRESS.....  
 SUBJECT OR EXAM THAT INTERESTS ME..... (SE.21.)

## LINE OUTPUT TRANSFORMERS

Most types available. State Make and Model Number of Receiver when ordering.

S.A.E. please with all enquiries.

### HOWORTH

51 POLLARD LANE, BRADFORD 2, YORKS.  
 Tel. 37030

## REBUILT TV TUBES

FULLY GUARANTEED 12 MONTHS  
 Complete New Gun fitted in every Tube

12in., 14in., ..	£5.0.0	17in. .. ..	£6.0.0
15in. .. ..	£5.10.0	21in. .. ..	£8.0.0

Immediate Delivery  
 Carriage and Insurance 10/- extra  
 Allowance on old tube

### NU-GUN TELETUBES LTD.

3 The Mews, Duckett Rd., Harringay, London, N.4.  
 Telephone: MOUNTVIEW 2903

## Factory Rebuilt . . . Super TELEVISION TUBES

All types fitted with New Gun Assembly. Fully guaranteed 12 months.

Mullard, Mazda, etc.:

12 inch .. ..	£5.0.0
14/15 inch.. ..	£5.10.0
17 inch .. ..	£6.0.0

Carriage and insurance 10/-  
 C.W.O., C.O.D. or Credit terms available. S.A.E. for all enquiries.

Allowance on old tube.  
**K.V.A. ELECTRONICS (Dept. P/1)**  
 3B Godstone Rd., Kenley, Surrey



## DOMINATOR

17 WATT TREMOLO AMPLIFIER

A top quality instrument designed for the professional who needs the best. The "Dominator" embodies all the tried and trusted features of the earlier models with detailed improvements made possible by the continuing research of Musical Designers. Natural quality of tone to suit the most discerning player. Generous valve line-up and circuit efficiency ensure ample volume and some to spare for all occasions together with the brilliant and sparkling attack associated with "Darwins" Amplifiers. Twin 12,000 line 10in. speakers drive in a cabinet geometrically angled to give maximum sound dispersion and directional treble impact. Comprehensive control panel is flush mounted for safety in transport and features: Four Inputs. Two volume controls. Two tone and depth controls provide "Full Compass" tremolo pulse combinations. Acoustically designed luxury appearance.

controls. Tremolo Speed control. Tremolo Depth control. Tremolo on/off by foot switch on wander lead. Tremolo speed cabinet, presented in two-tone leather cloth with gilt trim completes the striking and exclusive appearance.

Price £40.0.0 (Heavy quality waterproof cover 27/6d.)

A.C. MAINS 200-250 v. DOMINATOR Non-Tremolo model. Price £35.0.0

## DARWINS

19 GEORGE STREET, ST. HELENS, LANCs. Phone: St. Helens 4246.

## SPECIAL VALVE OFFER

For Limited Period

EB91	4/-	UF42	7/-	6L1	8/-
ECL80	7/6	UL41	7/-	6L18	9/-
ECL82	9/-	UL44	7/6	6P25	6/6
EF90	5/-	UL46	7/6	6LD20	7/6
EF91	4/-	UBC41	7/6	6SN7GT	5/6
EL36	10/6	UCH42	7/6	7QT	9/-
EY83	7/6	U35	8/6	10F1	6/6
GZ32	8/-	SP61	2/6	10P13	8/6
KT33C	6/6	3D6	2/6	10P14	8/6
KT36	8/6	6AT6	9/6	12AT7	9/6
PL33	9/-	6CH6	7/-	20D1	7/6
PL32	7/6	6SG9G	10/6	20F2	9/6
PL83	7/6	6F1	6/-	N37	8/-
PY80	7/-	6F13	6/-	ECC83	9/6
PY82	7/-	6F14	6/-	907	6/6
PZ30	11/-	6F15	9/-	PY31	7/6
UAF42	8/6	6J5GT	5/-	1625	6/-

Postage 4d. per Valve.

Coaxial Cable, 75 ohms. 6d. yd. Ion Traps. 5/-; Midget 2 Gangs. 6/6; New 7 x 4 P.M. Speakers Large or Small Masnet 16/-

TV AERIALS: We carry large stocks; send S.A.E. with your requirements and we shall reply and send leaflets by return.

MAIL ORDER ONLY — NO CALLERS  
 Terms: C.W.O. or C.O.D., minimum C.O.D. 3/-; postage, packing, other than valves, under £2, 1/6; under £5, 2/-; aerials 2/6.

**ELECTRO SERVICES & CO.**  
 221 BATTERSEA PARK RD., S.W.11  
 Mac. 6839/4

## NEW VALVES!

Guaranteed Set Tested  
 24 HOUR SERVICE

1R5, 1S5, 1T4, 3S4, 3V4, DAF91, DF91, DK91, DL92, DL94, SET of 4, 18/6.  
 DAF96, DF96, DK96, DL96, SET of 4, 26/6.

1D5	7/6	DL33	8/6	PCL82	7/6
1R5	5/6	DL35	9/6	PCL83	10/6
1S5	4/9	DL92	5/11	PCL84	7/6
1T4	3/11	DL94	6/9	PEN36C	8/-
3S4	5/11	DL96	6/11	PL36	10/9
3V4	6/9	EBF41	7/6	PL38	14/-
5U4G	4/9	EBF80	8/-	PL81	8/9
5Y3GT	5/9	ECC81	5/3	PL82	7/-
5Z4G	7/6	ECC82	6/-	PL83	7/6
6K7G	2/-	EY363	6/6	PY32	10/3
6K8G	5/3	ECC84	8/3	PY80	7/-
6Q7G	5/9	ECC85	8/-	PY81	5/9
6S1L7GT	6/-	ECCF80	9/-	PY82	6/3
6SN7GT	4/6	ECCF82	9/-	PY83	7/3
6V8G	5/-	UCH42	8/-	U25	13/-
6V8GT	6/3	ECL80	7/-	U26	11/-
6X5GT	5/-	EF41	7/9	U52	4/9
12K7GT	5/3	EF80	5/-	UABC90	7/6
12K9GT	11/-	EF85	7/6	UF42	8/9
12Q7GT	5/3	EF90	9/9	UBC41	7/3
35L6GT	8/-	EF89	7/-	UBF80	8/6
36Z4GT	6/-	EL41	7/3	UCC84	12/9
AZ31	8/9	EL84	6/6	UCC85	7/-
B96	8/3	EY51	7/11	UCF80	14/-
CL33	12/6	EY363	7/9	UCH42	7/9
DAC32	9/6	EZ40	6/3	UCH81	8/-
DAF91	4/9	EZ41	7/-	UCL82	10/-
DAF96	6/11	EZ80	6/-	UCL83	13/6
DF33	9/6	EZ81	8/9	UF41	7/9
DF91	3/11	GZ32	8/9	UF42	6/3
DF96	6/11	KT63	6/-	UF89	8/6
DH77	6/-	MU14	7/-	UL41	7/3
DK32	11/3	PCC84	7/3	UL84	7/6
DK91	5/6	PCC89	11/6	UY21	17/-
DK92	8/6	PCF80	8/9	UY85	8/3
DK96	6/11	PCF82	7/6	VP4B	8/6

Postage 6d. per valve extra. Any Parcel Insured Against Damage in Transit 6d. extra. Any C.O.D. Parcel 2/6 extra. Office address, no callers.

**GERALD BERNARD**  
 90 CARR MANOR AVENUE  
 LEEDS 17

## TV TUBES

12 MONTHS' GUARANTEE

12", 14", 17" — £5-10-0  
 21" — £7-10-0

Your old Tube required  
 C.W.O. 10/- Carriage

**JACK PEARSON**  
 77 High Street, Blackheath  
 Birmingham

**RES/CAP BRIDGE** 37/-  
 p. & p. 2/-  
 Checks all types of resistors, condensers  
 6 RANGES  
 Built in 1 hour. Direct reading  
**READY CALIBRATED**  
 Stamp for details of this and other kits.  
**RADIO MAIL (Dept. Bv)**  
 Raleigh Mews, Raleigh Street, Nottingham

## A SUPER SPECIAL TV TUBE OFFER

Unused tubes made by world-famous manufacturers complete with 12 months' maker's guarantee. 17in. Tube to replace the MW43-64 43-69, 171K, 172K, 17 ASP4, 17 AXP4, C17-1, C17-A, CR17-22, C17-FM, MW 43-80. Our Unbeatable Price £8.10.0. Also available brand new 14in. to replace 36-24, 36-44, TR14-22, TR14-22, 14 KP4A 14-LP4, 141K, C36-24, or for AW 36-20, 36-21 12in. brand new 31 MW 31-74, all at 27 each. Post packing and insurance 10/- extra.

## NEW MAX ELECTRONICS

for London's Finest Bargains in electronic and radio equipment. Also Largest Selection of Tape Recorders in the U.K. All Guaranteed.  
 220, Edgware Road, London, W.2.  
 Tel. PAD 5407

**GUARANTEED VALVES**

1L4	2/6	D77	3/6	PCF80	6/6
6F1	6/6	ECL80	7/6	PY80	6/6
6F15	7/6	EF80	5/-	PY82	6/6
10F1	6/6	EF91	3/-	SP61	6d.
20D1	9/6	EL32	3/-	UL46	7/6

All fully guaranteed for 3 months.  
 Postage 6d. each. Send S.A.E. for list.  
**SERVICE SHEETS, BOOKS COMPONENTS.**  
 Send stamp for lists.  
**HAMILTON RADIO (T)**  
 227 Sedlescombe Road North, Hastings, Sussex. (Mail orders only)

**WHEN REPLYING TO ADVERTISERS PLEASE MENTION PRACTICAL TELEVISION**

## B.B.C. - I.T.V. - F.M. AERIALS



B.B.C. (BAND 1). Telescopic loft, 19/6. External. S/D. 26/3.  
 I.T.V. (BAND 3). 3 Element loft array, 24/-, 5 Element, 32/6. Wall mounting, 3 Element. 33/9. 5 Element. 41/3.  
 COMBINED B.B.C. + I.T.V. Loft 1+3 Element. 41/3. 1+5 Element. 48/9. Wall mounting, 1+5 Element. 56/3. 1+5 Element 42/9. Chimney and mast mounting units also available.  
 F.M. (BAND 2). Loft 'H' 28/-, 3 Element loft, 52/6. S/D loft, 12/6. External S/D. 26/3. State channel when ordering. C.W.O. or C.O.D. P.P. 2/6. Coaxial cable, 9d. yd. Coaxial plugs, 1/3. Send 6d. stamps for illustrated lists.

**K.V.A. ELECTRONICS (Dept. T.P.)**  
 3b Godstone Road, Kenley, Surrey

A 3d. stamp will bring you a copy of our latest

**RADIO & TELEVISION COMPONENT Catalogue**  
**JAMES H. MARTIN & CO.**  
 FINSTHWAITHE, NEWBY BRIDGE  
 ULVERSTON, LANCs.

## TRANSFORMERS

Suppliers to B.B.C., I.T.A. and leading radio manufacturers, single or long runs, prompt delivery, home and export.

Rewinds to all makes.  
**H.W. FORREST (Transformers) Ltd.**  
 Shirley, Solihull, Warwickshire  
 Tel.: SHIRLEY 2483

## FIRST-CLASS TELEVISION and RADIO COURSES . . .

GET A CERTIFICATE!

After brief, intensely interesting study — undertaken at home in your spare time — YOU can secure your professional qualification or learn Servicing and Theory. Let us show you how!

### FREE GUIDE

The New Free Guide contains 132 pages of information of the greatest importance to those seeking such success compelling qualifications as A.M.Brit.I.R.E., City and Guilds Final Radio, P.M.G. Radio Amateurs' Exams., Gen. Cert. of Educ., London B.Sc. (Eng.), A. M. I. P. E., A.M.I.Mech.E., Draughtsmanship (all branches), etc., together with particulars of our remarkable Guarantee of

**SUCCESS OR NO FEE**  
 Write now for your copy of this invaluable publication. It may well prove to be the turning point in your career.

**FOUNDED 1885—OVER 150,000 SUCCESSES**

**NATIONAL INSTITUTE OF ENGINEERING**  
 (Dept. 462), 148, HOLBORN, LONDON, E.C.1.

S. Africa: P.O. Box 8417, Jo'burg.  
 Australia: P.O. Box 4570, Melbourne.



*Fringevision Ltd.*

MARLBOROUGH, WILTS. Phone : 657/8

**HOME**  
SPECIAL FITTINGS FOR BAND  
III, BAND I & RADIO F/M.  
Useful formulæ and hints for  
constructing your own aerial  
quickly and cheaply. Catalogue  
illustrating our increased range of  
Diecast Alloy Fittings, including  
Band III to Band I Mast Couplers,  
Reflector and Director Rod  
Holders, Insulators (both "Inline"  
and "H" types), Masthead Fit-  
tings, Masts and Elements, Chim-  
ney Brackets, etc. Send 1/- in  
stamps for the above, to:—

AS ADVERTISED ON TELEVISION

Save £££

12 Months' Guarantee

FACTORY REBUILT ...

# TELEVISION TUBES

ALL TYPES AND SIZES—Immediate Delivery  
FITTED WITH COMPLETE NEW GUN

Price

12" £5.0.0    14" £5.0.0    15" £5.15.0    17" £6.0.0  
21" £8.10.0

TERMS TO  
THE TRADE

Plus 10/- carriage and insurance.  
Cash with order or C.O.D.

**RE-VIEW (LONDON) LTD.**

10 High Street

Colliers Wood, S.W.19

Telephone: Liberty 3272

